

## Solutions











Insult WordSearch 21

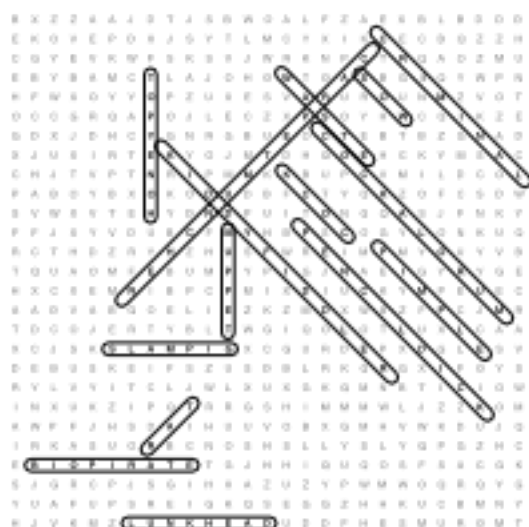

Insult WordSearch 22

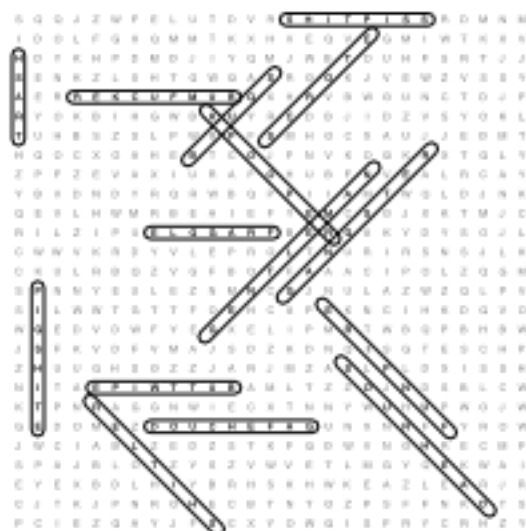

Insult WordSearch 23

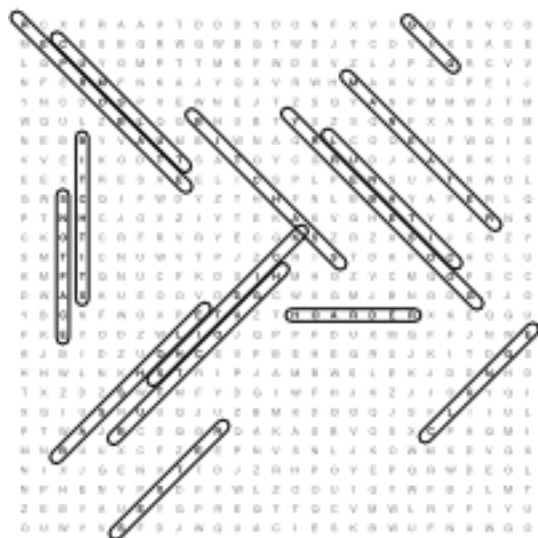

Insult WordSearch 24

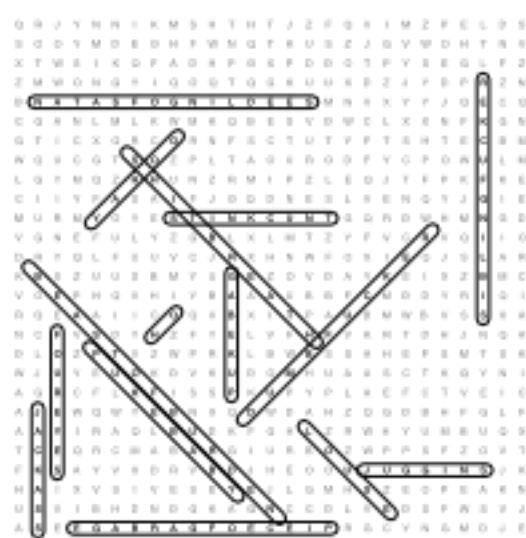















**Insult WordSearch 49**

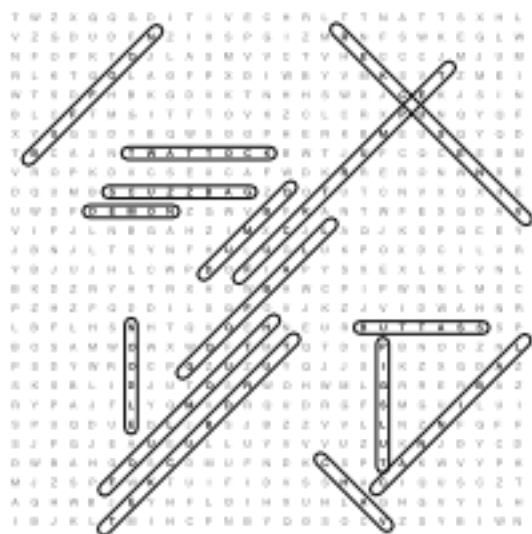

**Insult WordSearch 50**

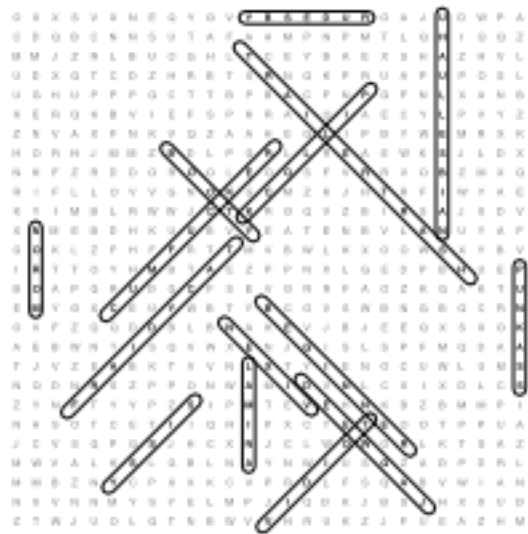

**Insult WordSearch 51**

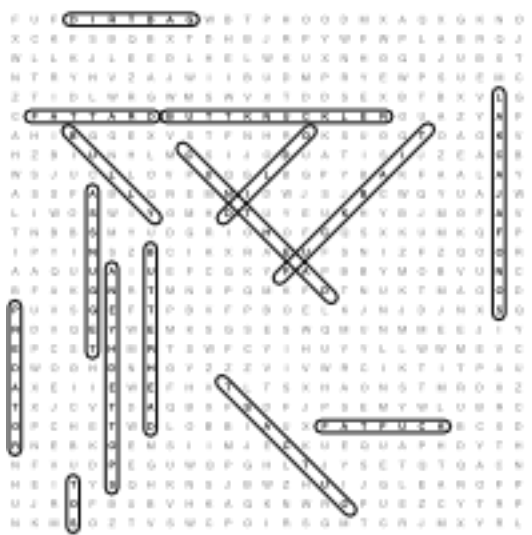

**Insult WordSearch 52**

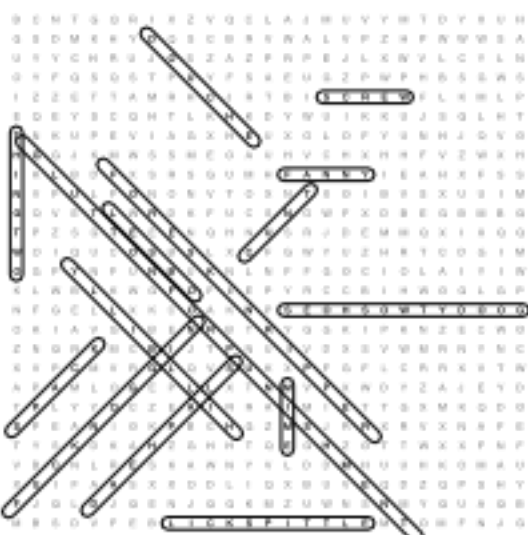











Insult WordSearch 69

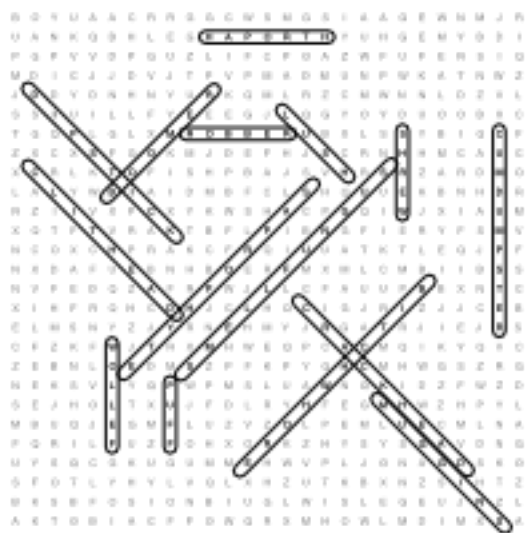

Insult WordSearch 70

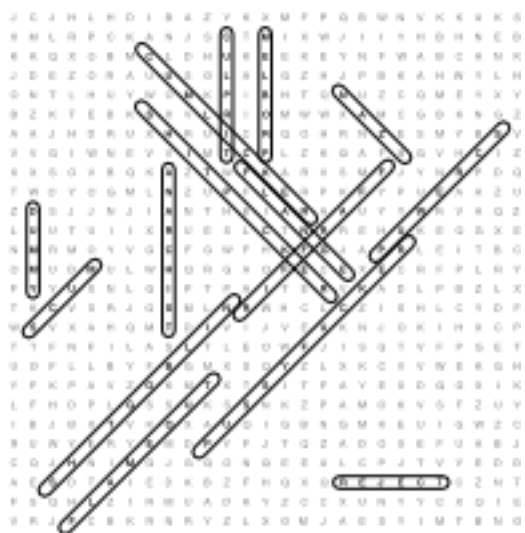

Insult WordSearch 71

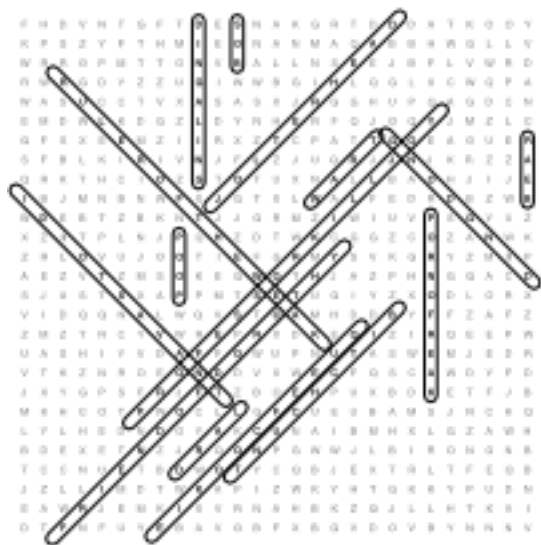

Insult WordSearch 72

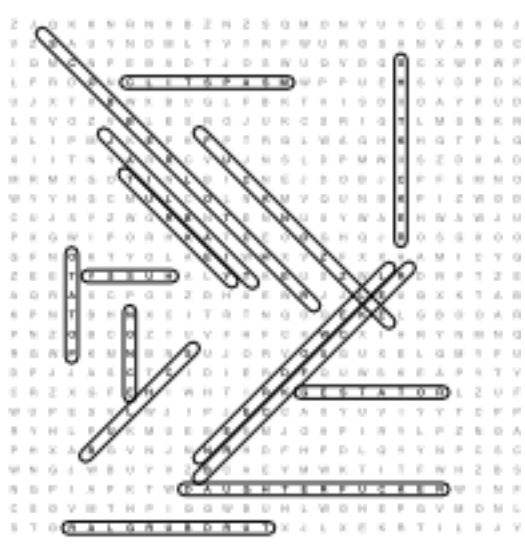



Insult WordSearch 77

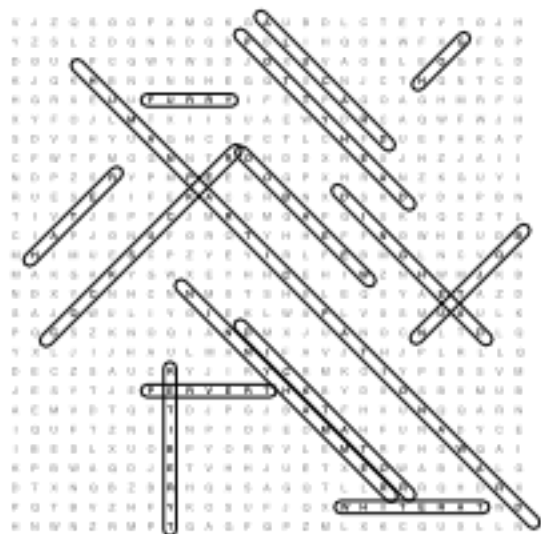

Insult WordSearch 78

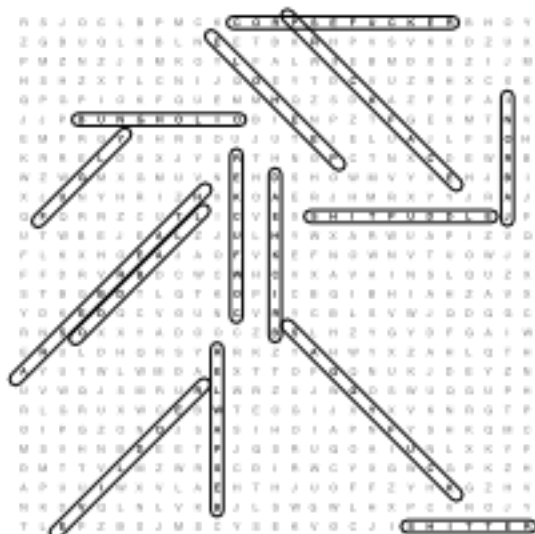

Insult WordSearch 79

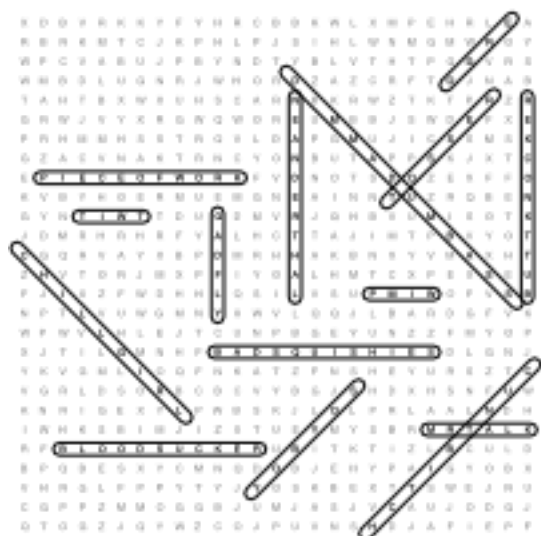

Insult WordSearch 80

