

Lösungen

SCHIMPFWORTSUCHE 1

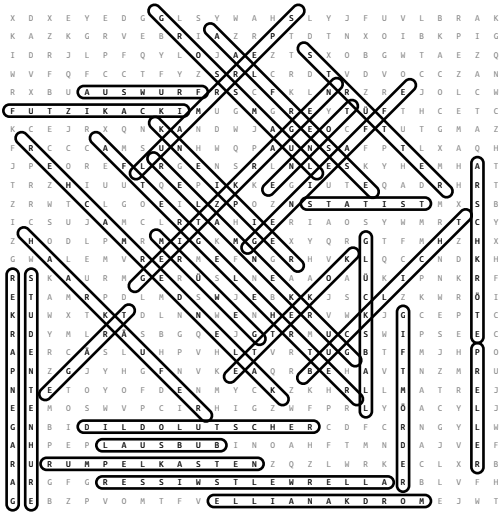

SCHIMPFWORTSUCHE 2

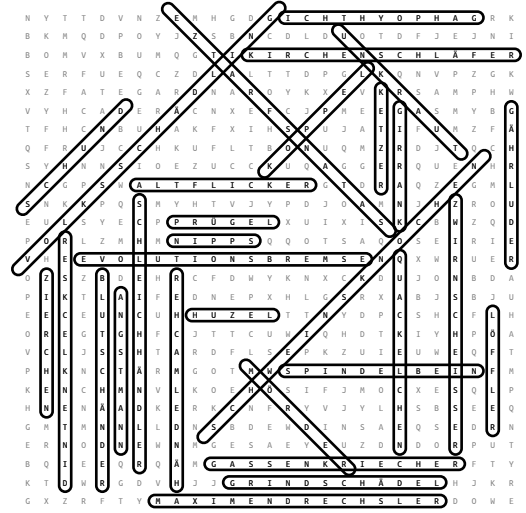

SCHIMPFWORTSUCHE 3

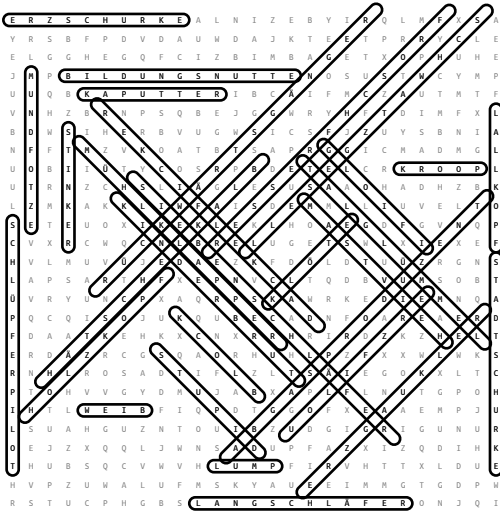

SCHIMPFWORTSUCHE 4

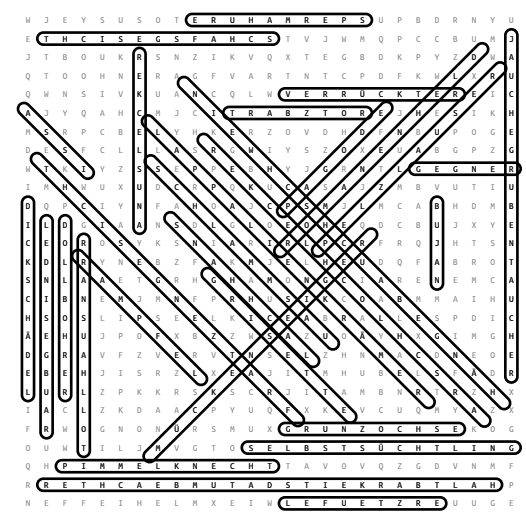

SCHIMPFWORTSUCHE 9

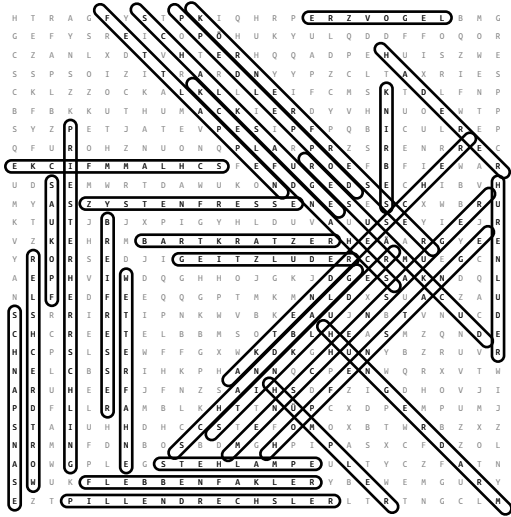

SCHIMPFWORTSUCHE 10

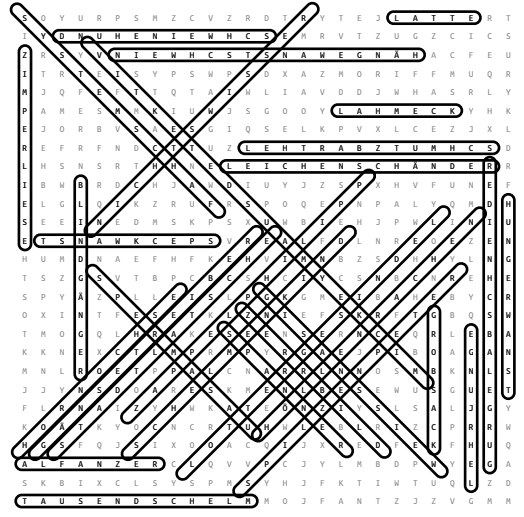

SCHIMPFWORTSUCHE 11

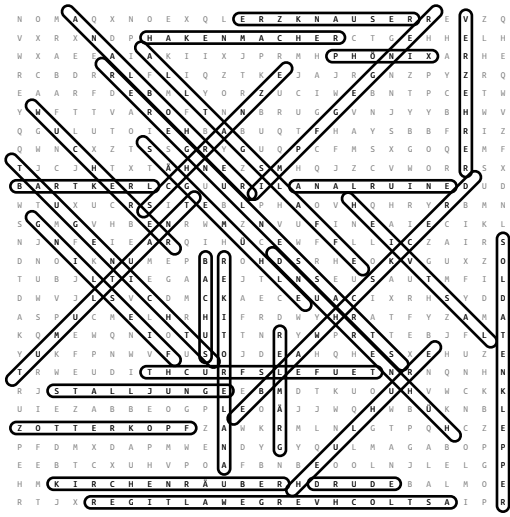

SCHIMPFWORTSUCHE 12

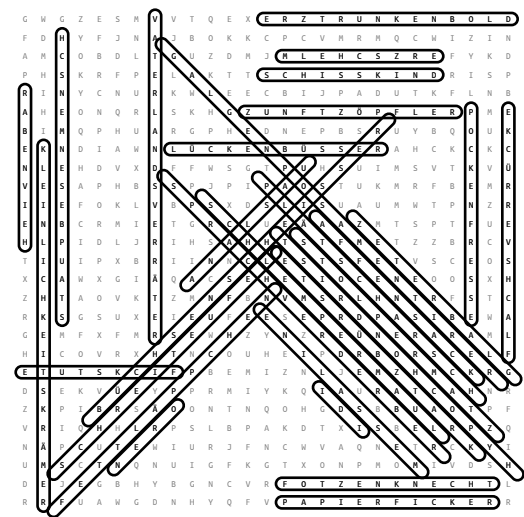

SCHIMPFWORTSUCHE 13

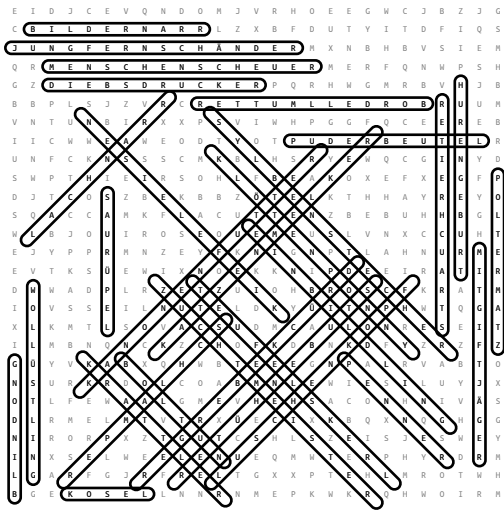

SCHIMPFWORTSUCHE 14

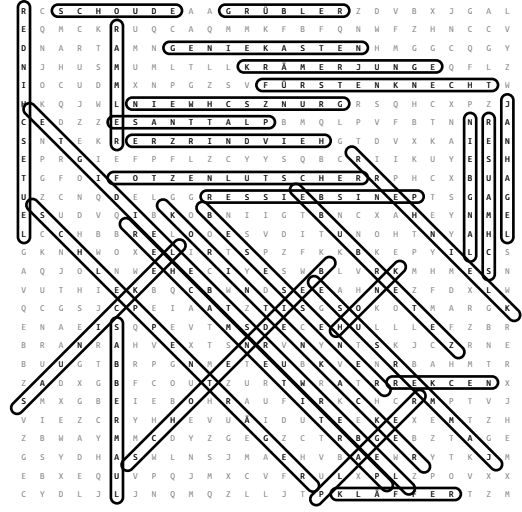

SCHIMPFWORTSUCHE 15

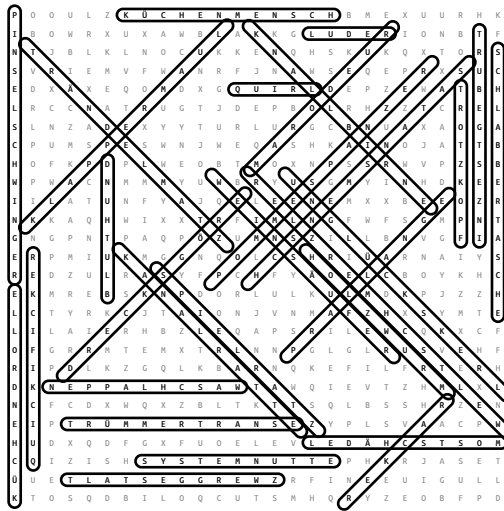

SCHIMPFWORTSUCHE 16

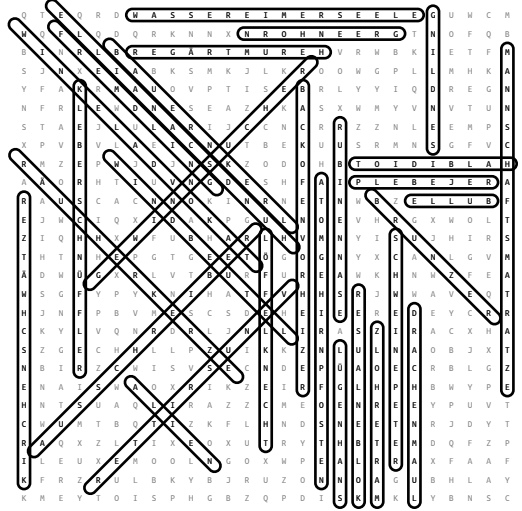

SCHIMPFWORTSUCHE 17

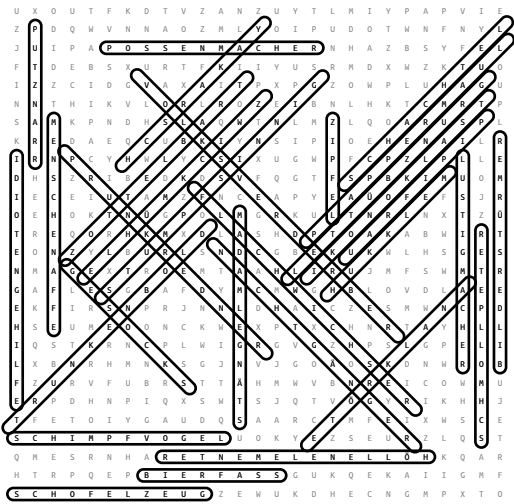

SCHIMPFWORTSUCHE 18

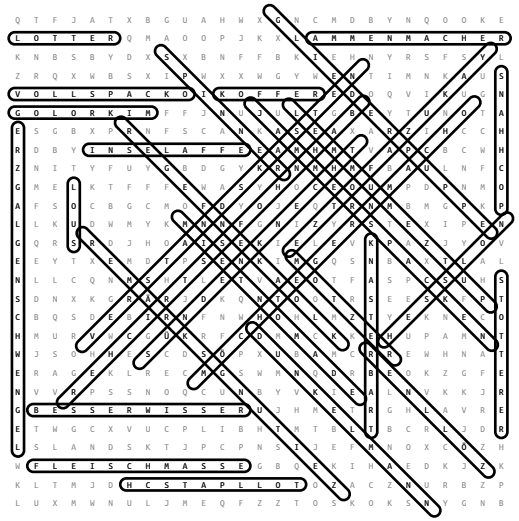

SCHIMPFWORTSUCHE 19

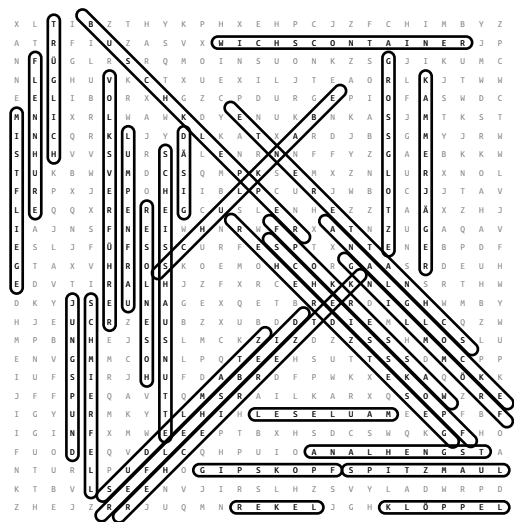

SCHIMPFWORTSUCHE 20

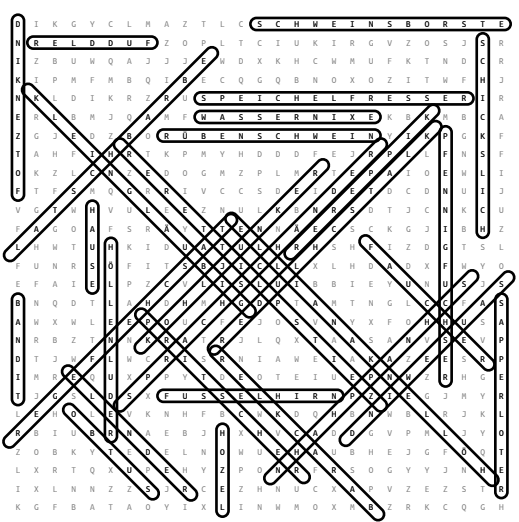

SCHIMPFWORTSUCHE 21

A crossword puzzle grid with various words highlighted in black boxes. The words are:

- EHCEBEFRÜTS
- LUNDIN
- FELPPOTS
- BRASSE
- DONTIKSGATNNOS
- LEINGEIS
- ALGENSCHLIFFE
- KORDBRENNE
- QUOERECTUS
- ANALRATTENSCHWANZLUISCHER
- SSIBBASLEFUE
- SCHIELE
- DICKSCHHEISSER
- EXTOURIS

SCHIMPFWORTSUCHE 22

A crossword puzzle grid with various words highlighted in black boxes. The words are:

- ARSKHU
- BEUTEERHER
- ASCETIER
- DISCOWCHSER

SCHIMPFWORTSUCHE 23

A crossword puzzle grid with various words highlighted in black boxes. The words are:

- EGTUA
- RAUSCHKIND
- CAUNE
- LANGRO
- ESHCITWSKNIL
- GALANTERIESCHWESTE

SCHIMPFWORTSUCHE 24

A crossword puzzle grid with various words highlighted in black boxes. The words are:

- ESHHCINEMWIP
- FREIBEUTER
- SCHNECKGESTALT
- ERHAB
- REFERTSDNA
- QUALSTERE
- LASTERBALO
- BRANKOPP
- HUCHELE
- KAUTERWELSCH

SCHIMPFWORTSUCHE 29

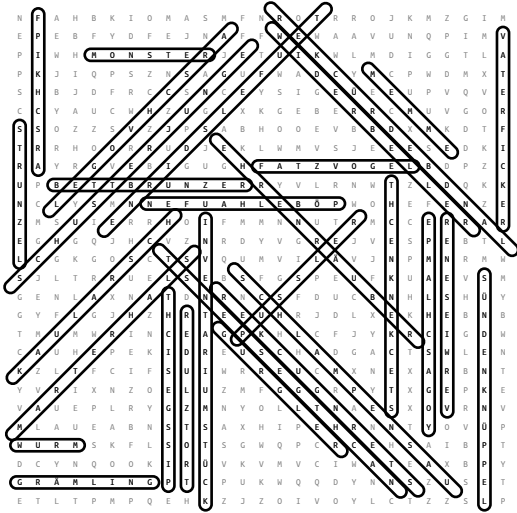

SCHIMPFWORTSUCHE 30

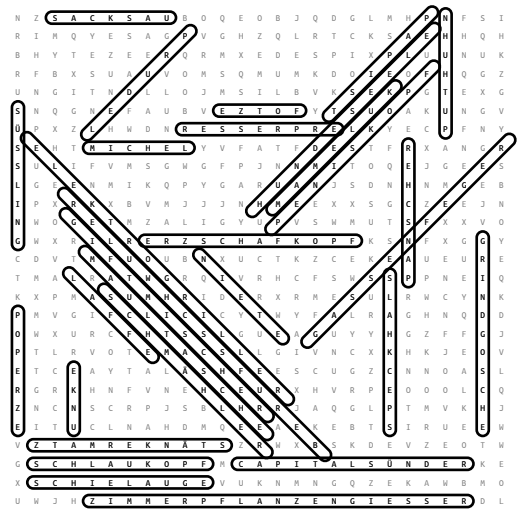

SCHIMPFWORTSUCHE 31

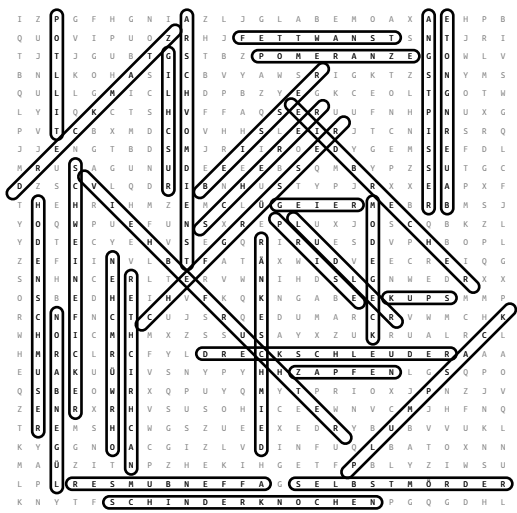

SCHIMPFWORTSUCHE 32

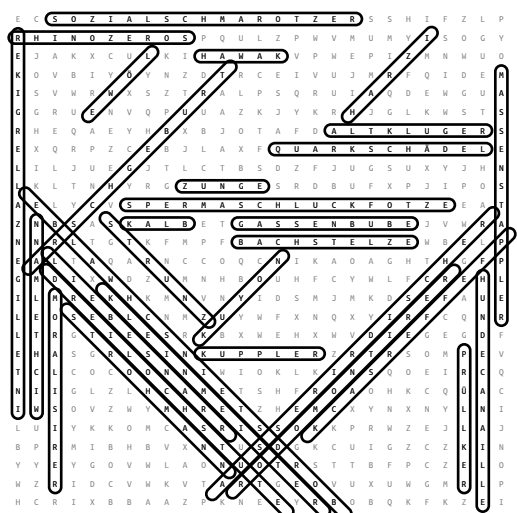

SCHIMPFWORTSUCHE 33

X Q J F C A C H R M A C H T S I C H U M P O B
 C A M P I N G I N H A C H T S I C H U M P O B
 F S D U T A L L E R M E I T S R A P P E L T S I C H
 U Q P V Q B G A S K O L N I E R P M A Z B V S I C H
 T O S Y L C G C H E R S T I N G E N D O S I T
 H O G X Y Z A U S A U S A U S A U S A U S A U S
 N N N Y S A U S A U S A U S A U S A U S A U S
 G O D X S T B M A G I C H E R S T I N G E N
 M O R Z U R V A J A N N E S P R A N K A N N
 W H C Z S H O G A G H A S E L C O R G M A
 H R Z I T Y E N D Y S E R Z S A U F E R P
 A E V G E I R B Y E S P A R C E N P A R C E
 I A N N E S P A R C E N P A R C E N P A R C E
 I I J H K G S A P P E L T S I C H U M P O B
 P M D H V E R A C K C H E R S T I N G E N
 E I G E G E H A J Z G K C X K K B U C H N
 V M H N C S 3 X H Z I N N H A N N E S P
 J M H N E I X X V D G F I X H A N N E S P
 U C H E I U I Z A D S A E N N A N N E S P
 N S A R T M X F T I T J D I N N E S P
 F I L W A N Q L E P L U B C T R E S S L D Q R
 N Q Z V W C T A L U B C T R E S S L D Q R
 D I S T E L F I N K E Z K L H L U

SCHIMPFWORTSUCHE 34

Y U F M B O D O O G A J E Q O F H N Y A
 L I B R Y H E B Z T V G J O B M I Y C X U Z B Z Z
 L Q H E V B U D P G A S K O L N I E R
 T T Z G D C K H O G E C F H P M A Z B V S I C H
 K I A L L E R M E I T S R A P P E L T S I C H
 T O R N P H H R A R O N U F F K T X T W Z
 R O Q V C P R L R O C K F O R C C C I
 V E I N G E R S T I N G E N D O S I T
 Z S M H O G E P O R C C I
 M P B D O G E P O R C C I
 K O V E R E R E R E R E R E R E R E R E R
 H R U P F S M A G I C H E R S T I N G E N
 I V D G S H M C C I
 S C H R I S T S I C H
 A E Z D S H M C C I
 N I S U V H L G C I
 H P C Z Q L Z Z I N N E S P
 L P M O H N N I N N E S P
 L I E I Y J Z I N N E S P
 N A N A R V Y K R O I N N E S P
 R N Z L Z O O I P K K I N N E S P
 F S L Z H Z J I N N E S P
 E Z E C N B O O B I N N E S P
 C H O H K X H X H X H X H X H X H X
 B J H Y O A J Y C P T H O H X H X H X
 E L L L G R F J D C H O L Y A H T C T K R W D U B N H

SCHIMPFWORTSUCHE 35

I O U P P I O B B R E U C A N I E R T U E R
 B U T L D K E W I R R K O P O T P I Z Z B J
 E N E O B U P O M E R Z A K R Z A S J I I N Y G O P
 E N O B U P O M E R Z A K R Z A S J I I N Y G O P
 N O R E D Z E R
 A T E N L E C K E R
 A N H A W
 K A N N E S P R A N K A N N E S P R A N K A N N
 H R C A G A S K O L N I E R P M A Z B V S I C H
 I T A C G U K U A N N E S P R A N K A N N
 S I T K X U O D I G G O O
 P D R Q X U O D I G G O O
 R E D I E N H C S B A F P O
 Z N N S A N D R I T T E R
 Y X B A P O Y S R B E N P
 X Z F O R E Z N U S P
 K X P I G U M H A N N E S P R A N K A N N
 M O O D W H E I N N E S P R A N K A N N
 L W O E G P C S S T V B I C H Z E R N D O S I
 Q J A W T S S T V B I C H Z E R N D O S I
 Z D N C U S S H A C R C C B E N P
 I C O D I S Z G Y E I D E O C C B E N P
 F C V S P B O N E G R A U L H E D
 I N N E S P O P P E R S I C H
 N A N N E S P E R R Q K E Z U Y I R J A N N
 N I R U Y O H C L C O K G R H D P S X S R I
 C T S Q T Y V Z C K C Z U V C J S G S K S R I

SCHIMPFWORTSUCHE 36

H O Q R C L A R S C H I L D E R
 X A I C E I N K R A C H E Z
 E O X S G I J X G V I T E S
 W A D I P C Z R I X W A N N E S P
 A A A A A A A A A A A A A A A A A A
 P S O D A N N E S P R A N K A N N
 V C D O V A N N E S P R A N K A N N
 H P P Z C G C H E R S T I N G E N
 N N W U C H E R S T I N G E N
 U R D U R D U R D U R D U R D U R D U R
 A T E J E A B P L F L H C
 D E Z H E S S W O C K X F E A U C S
 I B K W A H P U O C Q Q R Z I U I V
 B D H E F Z P U O C Q Q R Z I U I V
 U M H K Y H O G E P O R C C I
 L A M C D Q C I N N E S P
 S I X C O S M T P O C H E R S T I N G E N
 R S B A I N N E S P I N N E S P
 I O U D L Q Q C C A N N E S P R U Z
 C Z N R Y R E I N N E S P
 J K R E A T Y R H B A N N E S P
 G A F T O S
 S T E N E S A
 T S I E G S T I E K H C I L N T E L
 S C H R E I C H E L K A F Z U H V F G L C V L

SCHIMPFWORTSUCHE 37

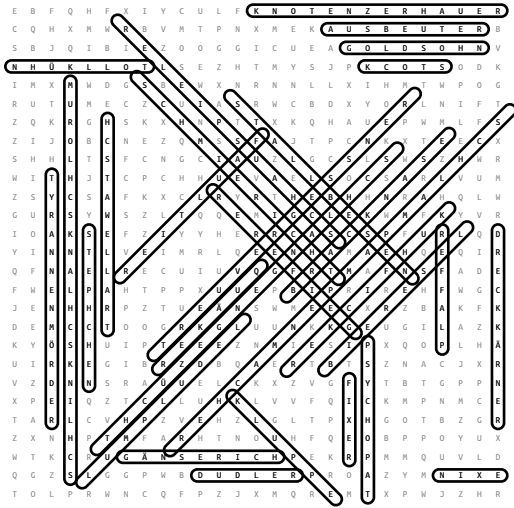

SCHIMPFWORTSUCHE 38

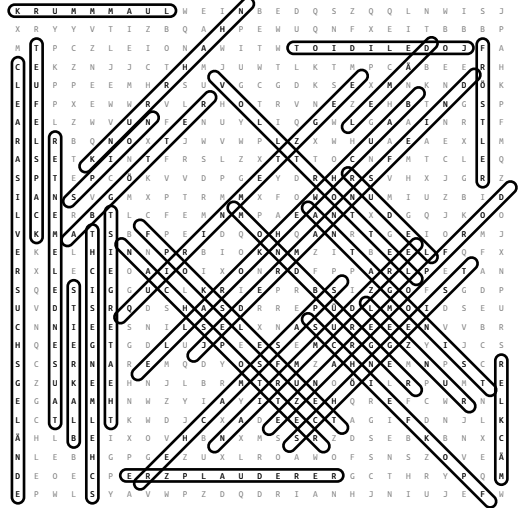

SCHIMPFWORTSUCHE 39

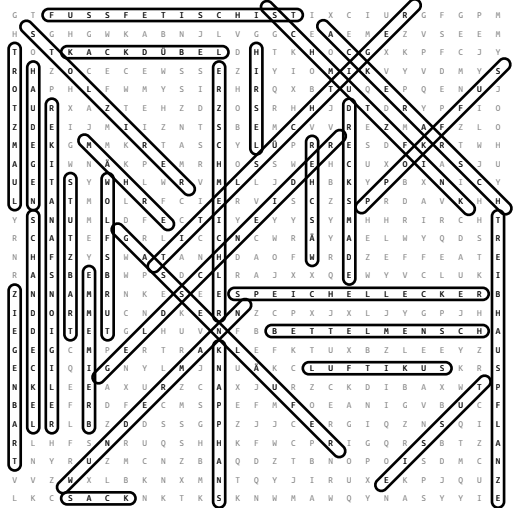

SCHIMPFWORTSUCHE 40

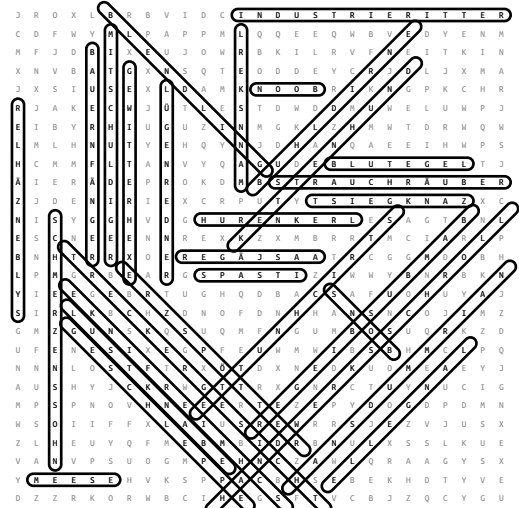

SCHIMPFWORTSUCHE 41

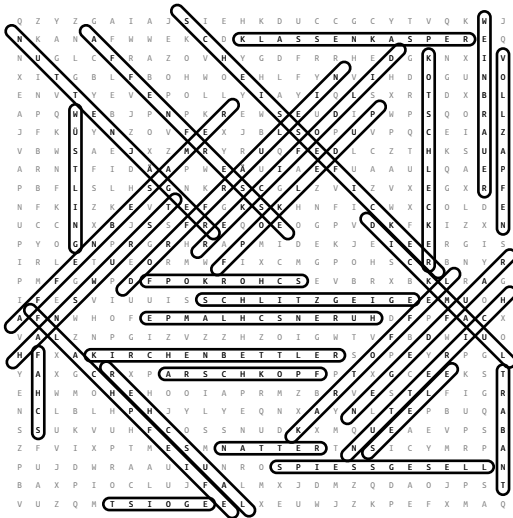

SCHIMPFWORTSUCHE 42

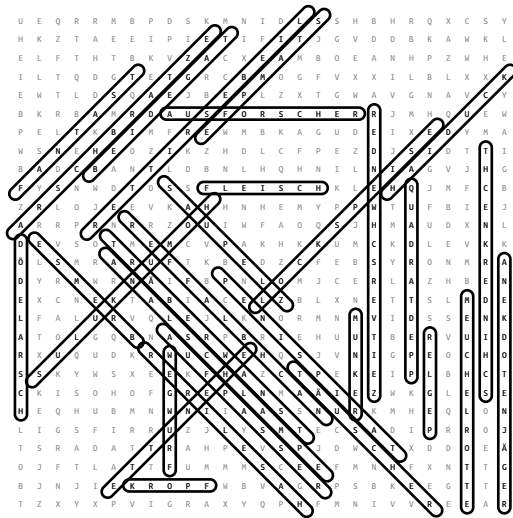

SCHIMPFWORTSUCHE 43

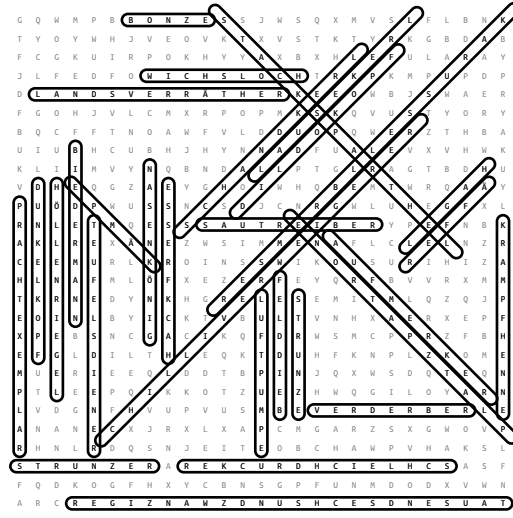

SCHIMPFWORTSUCHE 44

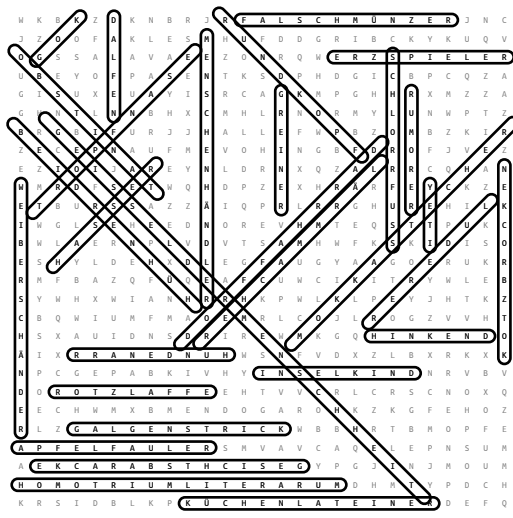

SCHIMPFWORTSUCHE 49

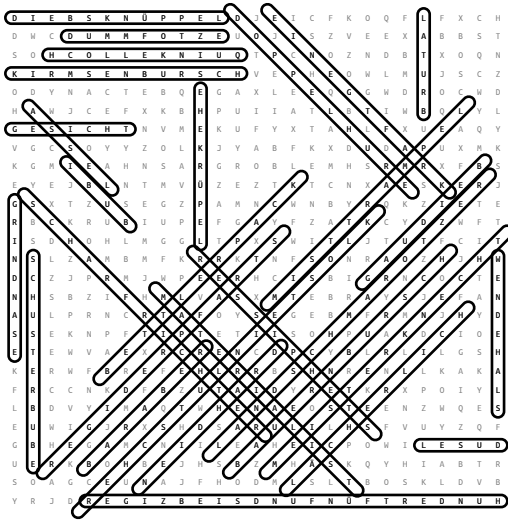

SCHIMPFWORTSUCHE 50

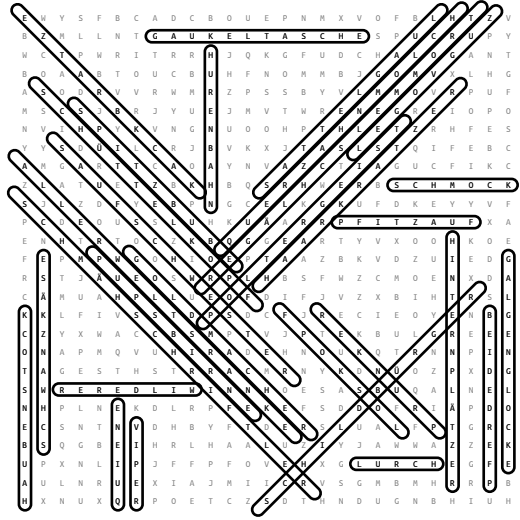

SCHIMPFWORTSUCHE 51

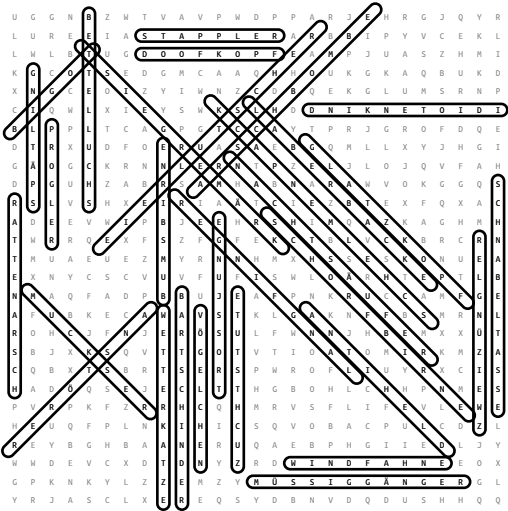

SCHIMPFWORTSUCHE 52

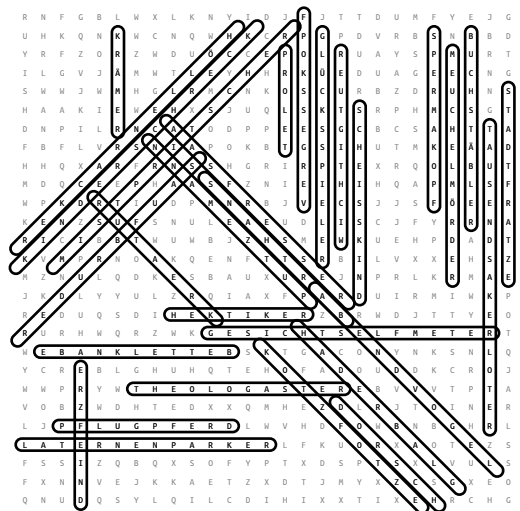

SCHIMPFWORTSUCHE 53

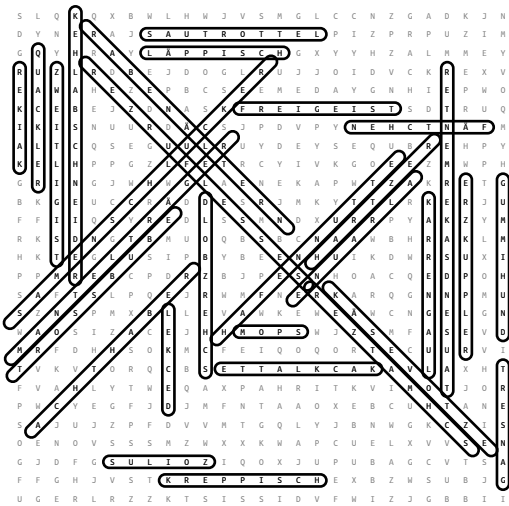

SCHIMPFWORTSUCHE 54

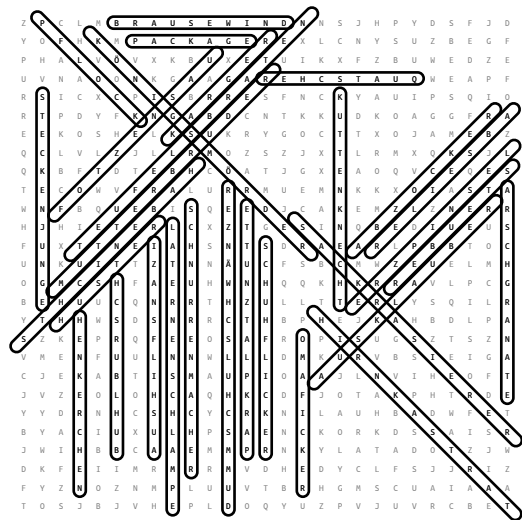

SCHIMPFWORTSUCHE 55

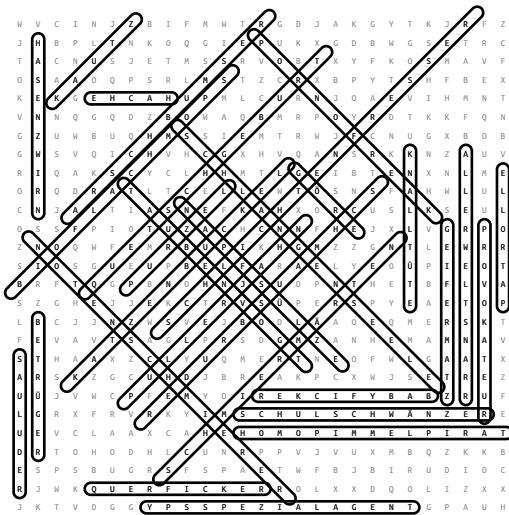

SCHIMPFWORTSUCHE 56

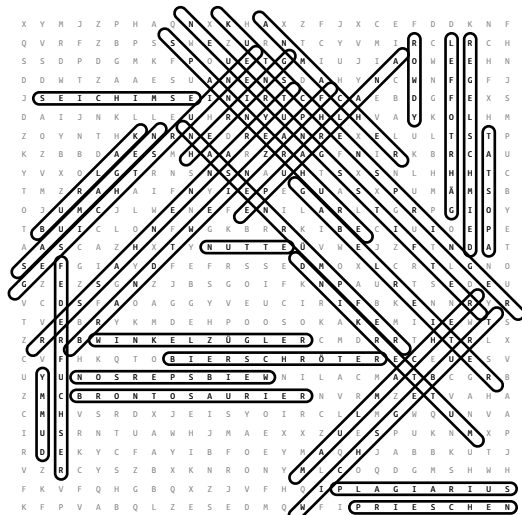

SCHIMPFWORTSUCHE 57

A 20x20 grid of letters with various words highlighted in white boxes. The words are:

- RELIGIÖSNAER (horizontal, row 14, columns 10-20)
- TRUBEGESSIM (horizontal, row 15, columns 10-20)
- POKLEDURTS (horizontal, row 16, columns 10-20)
- TAGELÖHNER (horizontal, row 20, columns 10-20)
- AUBSSUCHTI (horizontal, row 21, columns 10-20)
- RUHSHCEVBA (horizontal, row 22, columns 10-20)
- REINER (vertical, column 14, rows 10-20)
- REINER (vertical, column 15, rows 10-20)
- REINER (vertical, column 16, rows 10-20)
- REINER (vertical, column 17, rows 10-20)
- REINER (vertical, column 18, rows 10-20)
- REINER (vertical, column 19, rows 10-20)
- REINER (vertical, column 20, rows 10-20)
- REINER (vertical, column 10, rows 10-20)
- REINER (vertical, column 11, rows 10-20)
- REINER (vertical, column 12, rows 10-20)
- REINER (vertical, column 13, rows 10-20)
- REINER (vertical, column 14, rows 10-20)
- REINER (vertical, column 15, rows 10-20)
- REINER (vertical, column 16, rows 10-20)
- REINER (vertical, column 17, rows 10-20)
- REINER (vertical, column 18, rows 10-20)
- REINER (vertical, column 19, rows 10-20)
- REINER (vertical, column 20, rows 10-20)

SCHIMPFWORTSUCHE 58

A 20x20 grid of letters with various words highlighted in white boxes. The words are:

- INFALTSNARD (horizontal, row 14, columns 10-20)
- POKSBLA (horizontal, row 15, columns 10-20)
- BECKHAMRE (horizontal, row 16, columns 10-20)
- KRAMER (horizontal, row 17, columns 10-20)
- UNNRE (horizontal, row 18, columns 10-20)
- REINER (vertical, column 14, rows 10-20)
- REINER (vertical, column 15, rows 10-20)
- REINER (vertical, column 16, rows 10-20)
- REINER (vertical, column 17, rows 10-20)
- REINER (vertical, column 18, rows 10-20)
- REINER (vertical, column 19, rows 10-20)
- REINER (vertical, column 20, rows 10-20)
- REINER (vertical, column 10, rows 10-20)
- REINER (vertical, column 11, rows 10-20)
- REINER (vertical, column 12, rows 10-20)
- REINER (vertical, column 13, rows 10-20)
- REINER (vertical, column 14, rows 10-20)
- REINER (vertical, column 15, rows 10-20)
- REINER (vertical, column 16, rows 10-20)
- REINER (vertical, column 17, rows 10-20)
- REINER (vertical, column 18, rows 10-20)
- REINER (vertical, column 19, rows 10-20)
- REINER (vertical, column 20, rows 10-20)

SCHIMPFWORTSUCHE 59

A 20x20 grid of letters with various words highlighted in white boxes. The words are:

- SYSTEMLINIC (horizontal, row 14, columns 10-20)
- ARSCHEISSER (horizontal, row 15, columns 10-20)
- DORRITSCHE (horizontal, row 20, columns 10-20)
- SELAUQHETV (horizontal, row 21, columns 10-20)
- LORP (horizontal, row 22, columns 10-20)
- REINER (vertical, column 14, rows 10-20)
- REINER (vertical, column 15, rows 10-20)
- REINER (vertical, column 16, rows 10-20)
- REINER (vertical, column 17, rows 10-20)
- REINER (vertical, column 18, rows 10-20)
- REINER (vertical, column 19, rows 10-20)
- REINER (vertical, column 20, rows 10-20)
- REINER (vertical, column 10, rows 10-20)
- REINER (vertical, column 11, rows 10-20)
- REINER (vertical, column 12, rows 10-20)
- REINER (vertical, column 13, rows 10-20)
- REINER (vertical, column 14, rows 10-20)
- REINER (vertical, column 15, rows 10-20)
- REINER (vertical, column 16, rows 10-20)
- REINER (vertical, column 17, rows 10-20)
- REINER (vertical, column 18, rows 10-20)
- REINER (vertical, column 19, rows 10-20)
- REINER (vertical, column 20, rows 10-20)

SCHIMPFWORTSUCHE 60

A 20x20 grid of letters with various words highlighted in white boxes. The words are:

- ENRITHCSEBNERU (horizontal, row 14, columns 10-20)
- INTENKLECKSER (horizontal, row 15, columns 10-20)
- CHEISSHAUSFLIEGG (horizontal, row 16, columns 10-20)
- REINER (vertical, column 14, rows 10-20)
- REINER (vertical, column 15, rows 10-20)
- REINER (vertical, column 16, rows 10-20)
- REINER (vertical, column 17, rows 10-20)
- REINER (vertical, column 18, rows 10-20)
- REINER (vertical, column 19, rows 10-20)
- REINER (vertical, column 20, rows 10-20)
- REINER (vertical, column 10, rows 10-20)
- REINER (vertical, column 11, rows 10-20)
- REINER (vertical, column 12, rows 10-20)
- REINER (vertical, column 13, rows 10-20)
- REINER (vertical, column 14, rows 10-20)
- REINER (vertical, column 15, rows 10-20)
- REINER (vertical, column 16, rows 10-20)
- REINER (vertical, column 17, rows 10-20)
- REINER (vertical, column 18, rows 10-20)
- REINER (vertical, column 19, rows 10-20)
- REINER (vertical, column 20, rows 10-20)

SCHIMPFWORTSUCHE 61

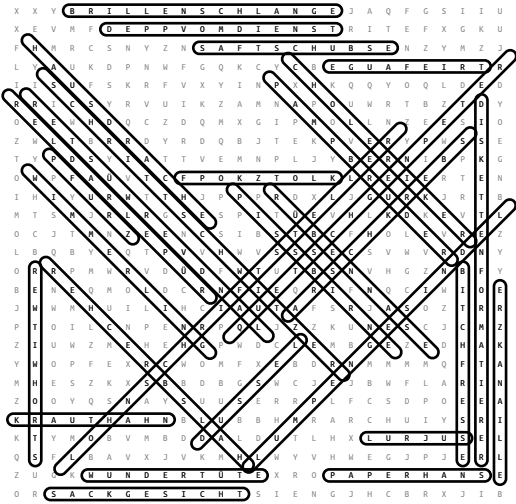

SCHIMPFWORTSUCHE 62

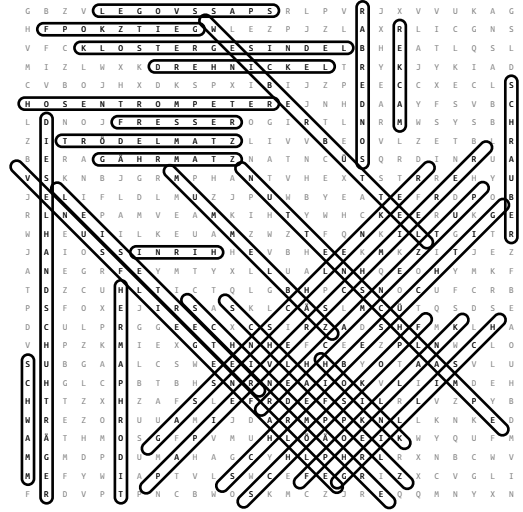

SCHIMPFWORTSUCHE 63

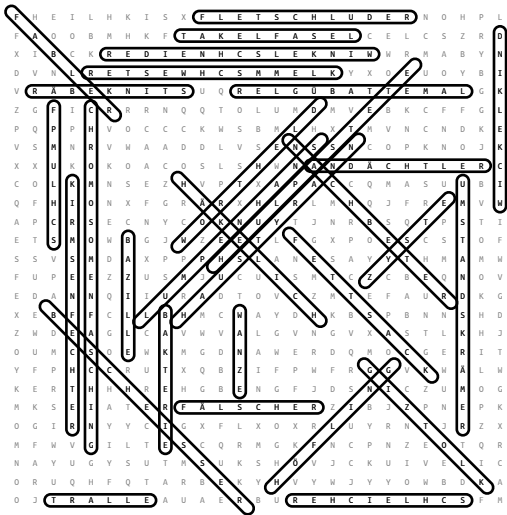

SCHIMPFWORTSUCHE 64

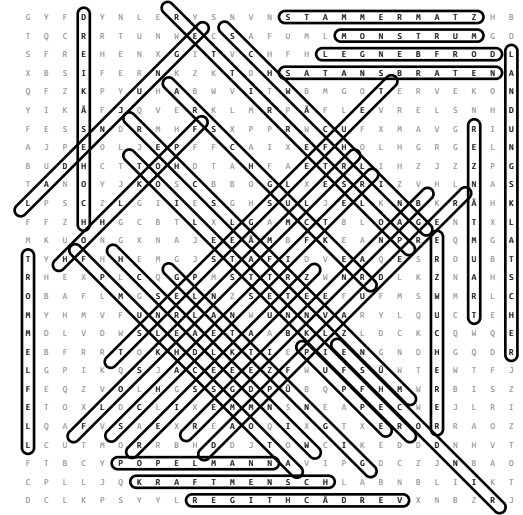

SCHIMPFWORTSUCHE 65

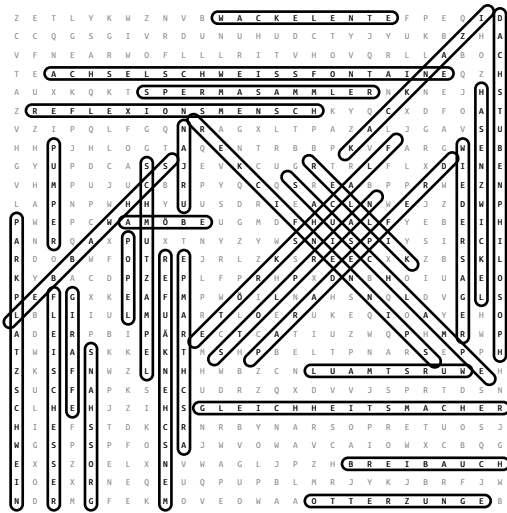

SCHIMPFWORTSUCHE 66

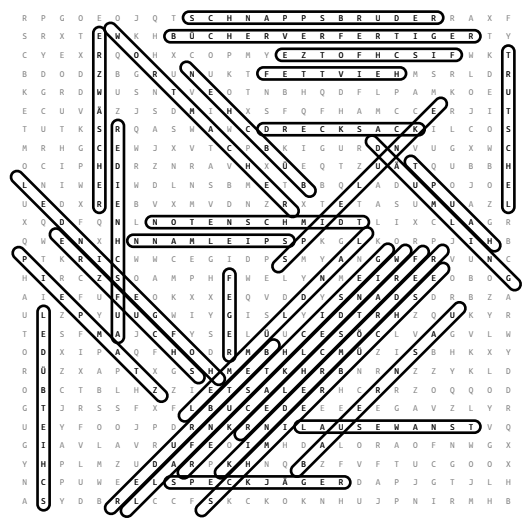

SCHIMPFWORTSUCHE 67

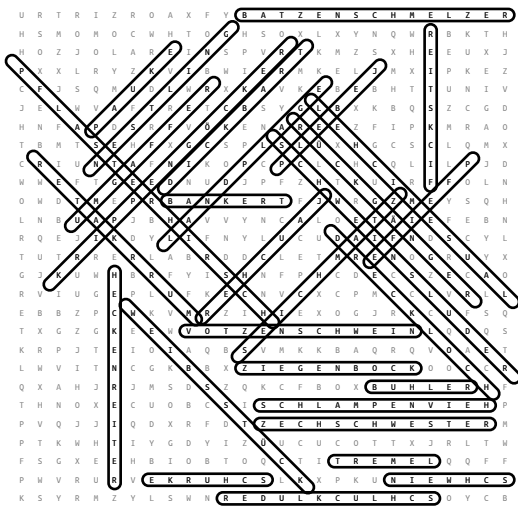

SCHIMPFWORTSUCHE 68

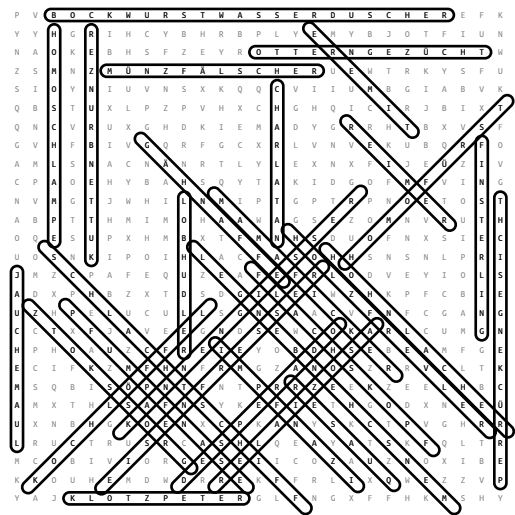

SCHIMPFWORTSUCHE 69

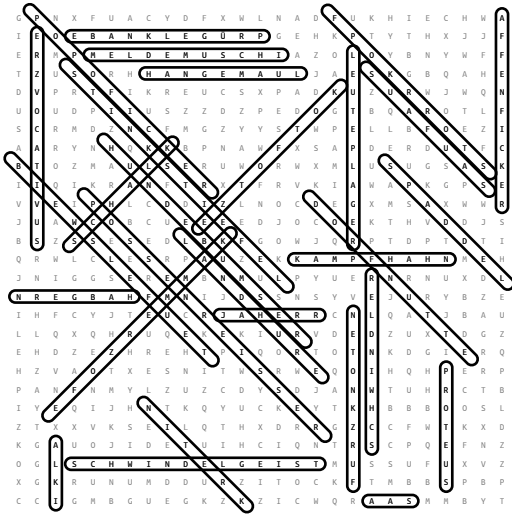

SCHIMPFWORTSUCHE 70

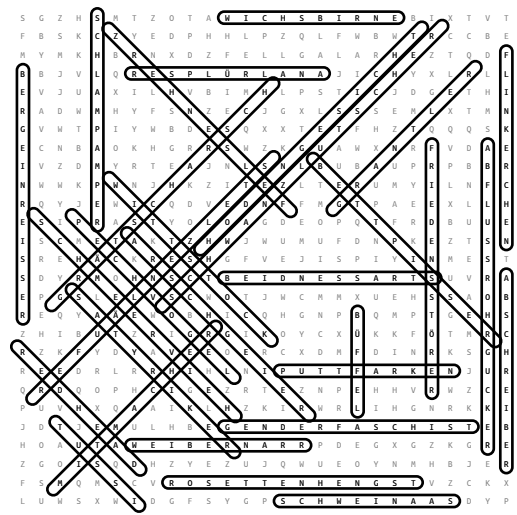

SCHIMPFWORTSUCHE 71

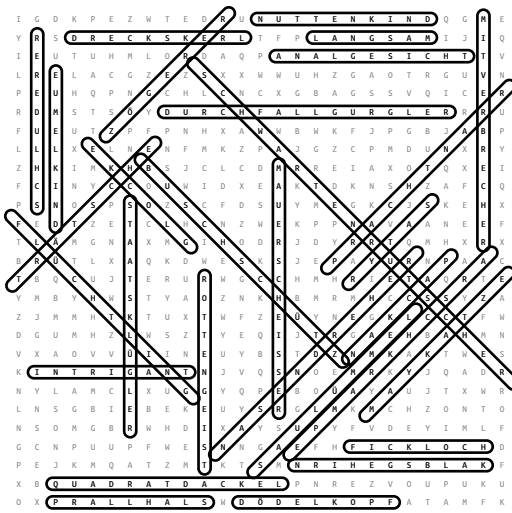

SCHIMPFWORTSUCHE 72

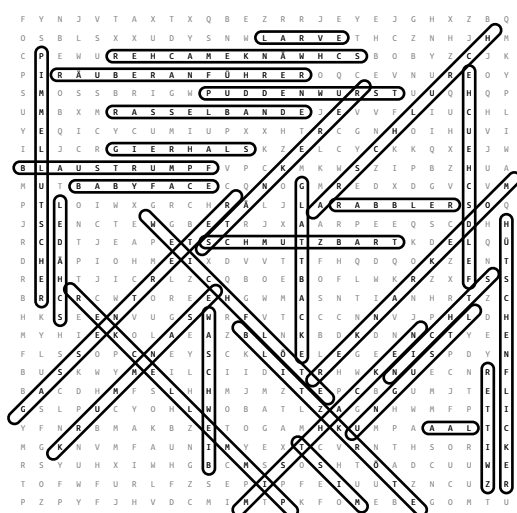

SCHIMPFWORTSUCHE 73

A crossword puzzle grid with words highlighted in black boxes. The words are:

- NEHCNHO SARA
- HRAMHC
- ASSERAAZ
- HILCHGESICR
- Vertical words: AAS, HEC, NCK, KL, P, F, E, C, Y, R, I, D, B, K, P, I, A, Z, P, F, T, D, R, T, U, G, I, N, G, L, S, U, Z, T, T, F, R, C, H, E, E, I, T, H, Z, I, A, O, U, X, F, C, B.

SCHIMPFWORTSUCHE 74

A crossword puzzle grid with words highlighted in black boxes. The words are:

- RENUASOP
- ACKSTLZ
- NERBUH
- SCHANDBRITTT
- DIRNENS PROSS
- GELPTSER
- KINDSKOPF
- Vertical words: E, H, S, J, A, C, G, P, C, C, O, T, H, B, L, E, O, C, S, S, R, G, C, H, E, S, L, A, C, R, N, D, C, R, B, G, C, D, F, R, E, Y, H, E, G, U, N, L, O, Z, B, R, G, C, O, D, P, X, J, U, K, H, S, C, H, N, E, N, S, P, R, O, S, S, D, F, Y, H, N, V, Z, O, R, E, N, A, S, U, F.

SCHIMPFWORTSUCHE 75

A crossword puzzle grid with words highlighted in black boxes. The words are:

- GLATTBARTIG
- RESPUTSEKCA
- GADENSCHMENGE
- BETTLEARBOTTT
- HCSPPA
- Vertical words: A, U, I, T, B, A, M, S, D, M, J, F, D, M, A, V, L, O, P, T, J, L, F, L, A, T, S, C, H, B, A, R, B, U, Z, D, R, I, Y, D, P, Y, R, C, K, E, A, G, D, G, C, P, H, A, L, U, G, G, J, H, E, L, H, W, D, P, H, A, S, E, I, V, D, K, M, D, K, U, E, R, I, E, C, N, J, R, R, D, I, N, Z, R, X.

SCHIMPFWORTSUCHE 76

A crossword puzzle grid with words highlighted in black boxes. The words are:

- NATTERNBURU
- KLATSCHBARB
- Vertical words: E, C, G, I, P, O, R, R, K, G, D, H, E, S, A, Z, H, Y, U, D, D, B, H, J, K, L, A, A, P, O, L, I, H, A, S, Y, R, F, E, L, A, X, P, U, O, Y, T, A, B, U, E, A, K, P, Z, N, R, O, A, H, E, S, E, S, E, X, C, I, A, B, U, O, D, U, O, Y, A, D, H, F, T, X, V, F, Y, Z, N, J, L, F, L, E, U, C, L, L, E, N, G, C, U, T, R, G, O, S, U, K, H, O, Y, C, H, A, D, Z, N, I, R, V, L, K, H, V, K, R, E, T, F, I, E, V, N, E, R, N, U, R, D, Y, C, G, O, O, O, P, E, U.

SCHIMPFWORTSUCHE 77

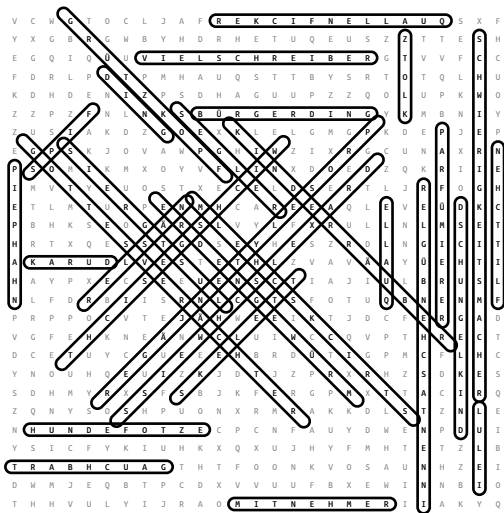

SCHIMPFWORTSUCHE 78

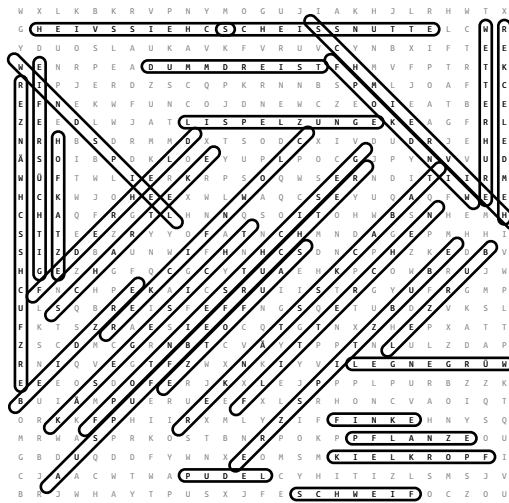

SCHIMPFWORTSUCHE 79

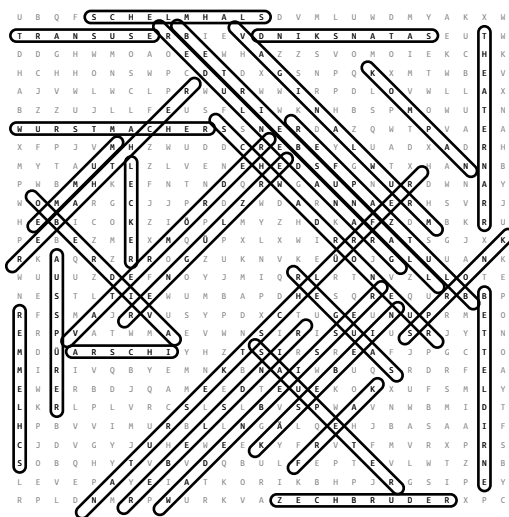

SCHIMPFWORTSUCHE 80

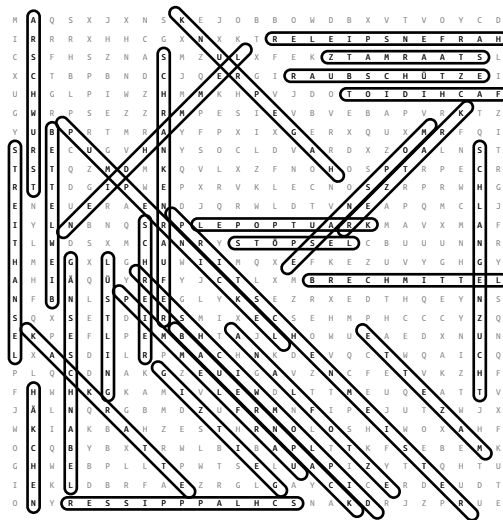

SCHIMPFWORTSUCHE 81

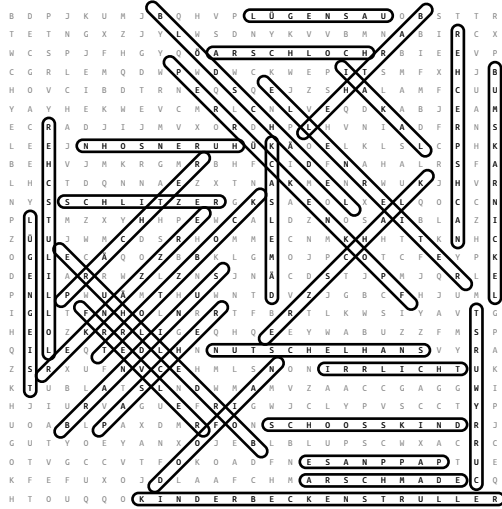

SCHIMPFWORTSUCHE 82

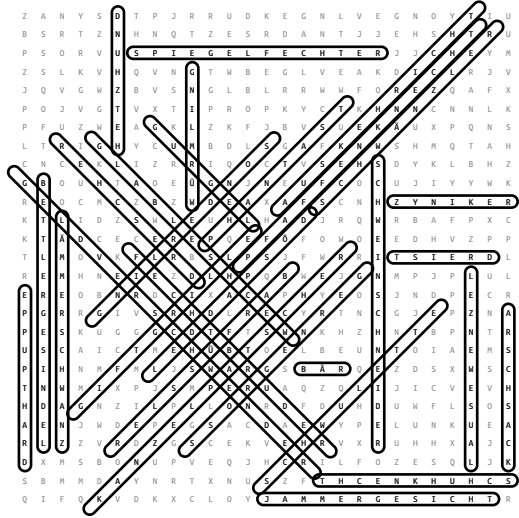

SCHIMPFWORTSUCHE 83

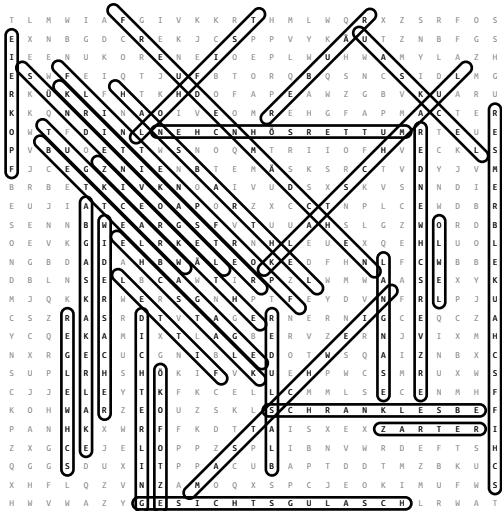

SCHIMPFWORTSUCHE 84

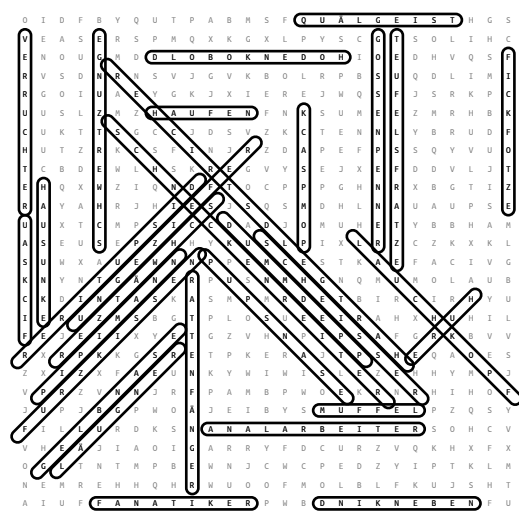

SCHIMPFWORTSUCHE 89

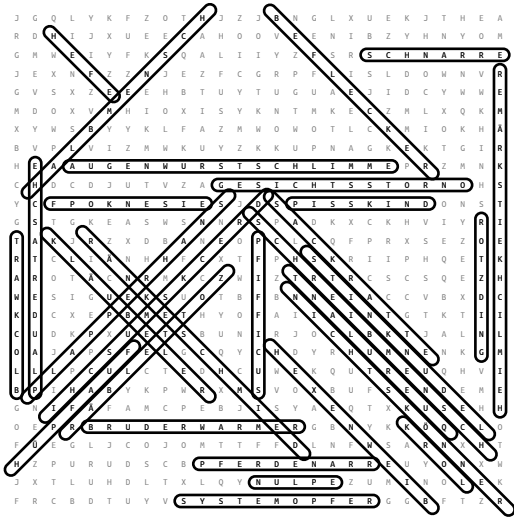

SCHIMPFWORTSUCHE 90

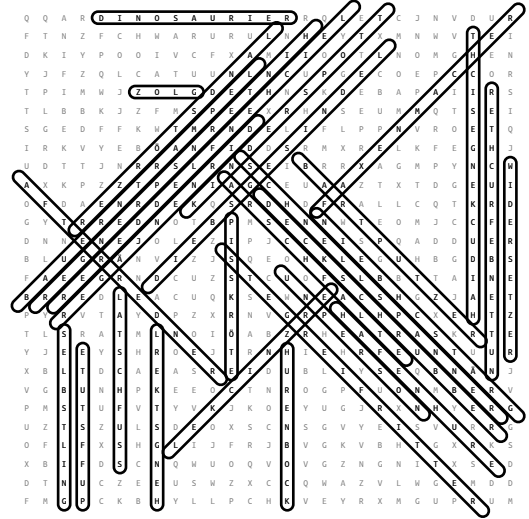

SCHIMPFWORTSUCHE 91

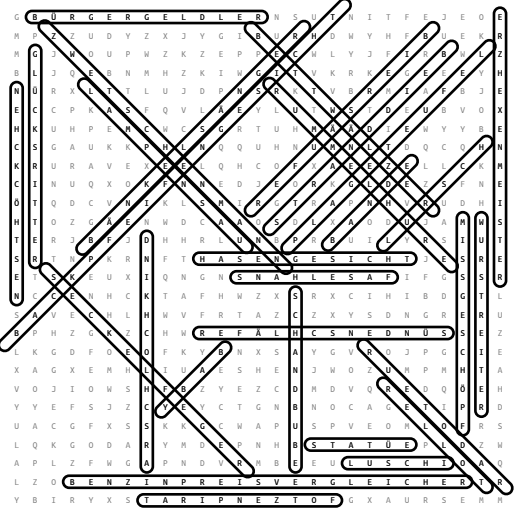

SCHIMPFWORTSUCHE 92

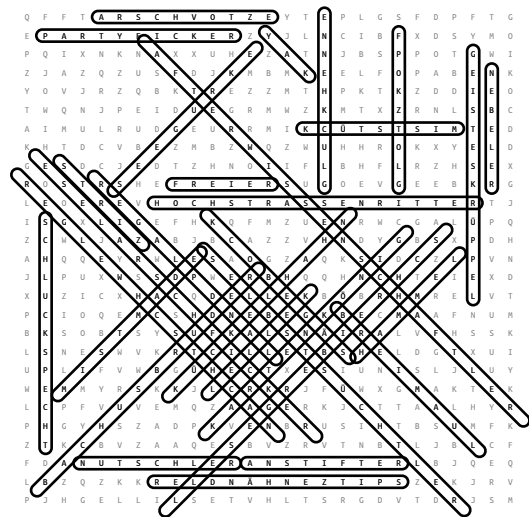

SCHIMPFWORTSUCHE 93

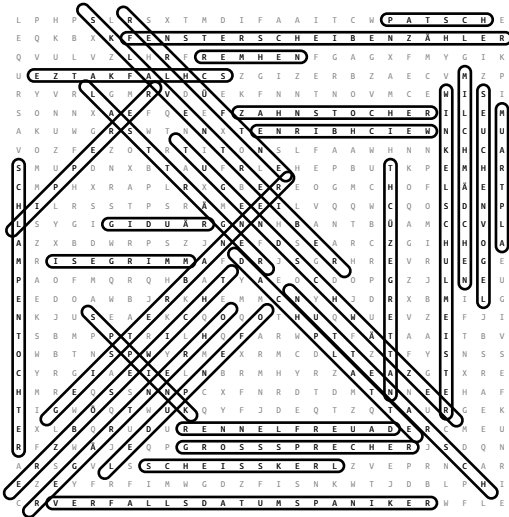

SCHIMPFWORTSUCHE 94

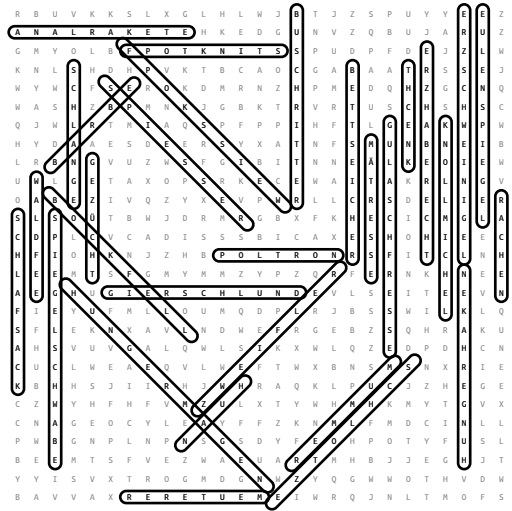

SCHIMPFWORTSUCHE 95

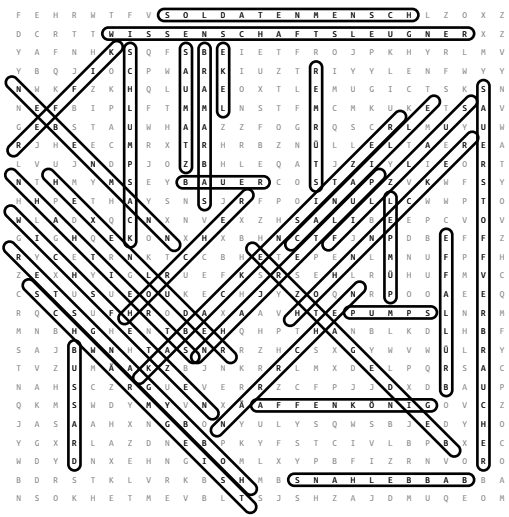

SCHIMPFWORTSUCHE 96

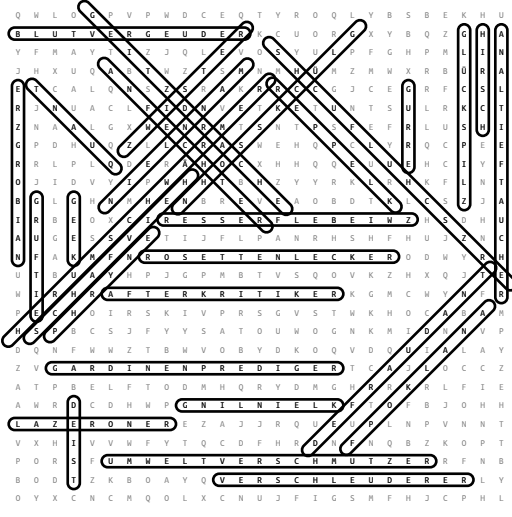

SCHIMPFWORTSUCHE 101

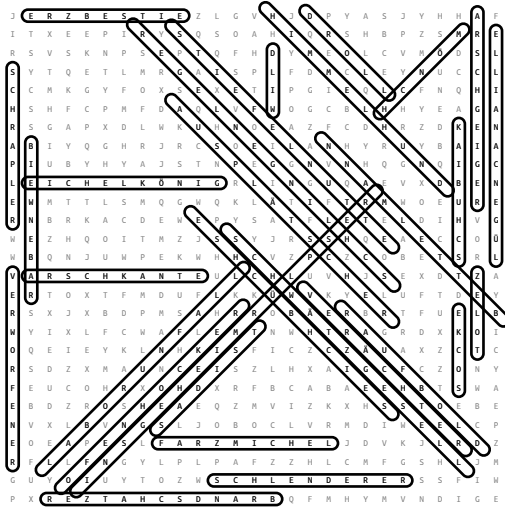

SCHIMPFWORTSUCHE 102

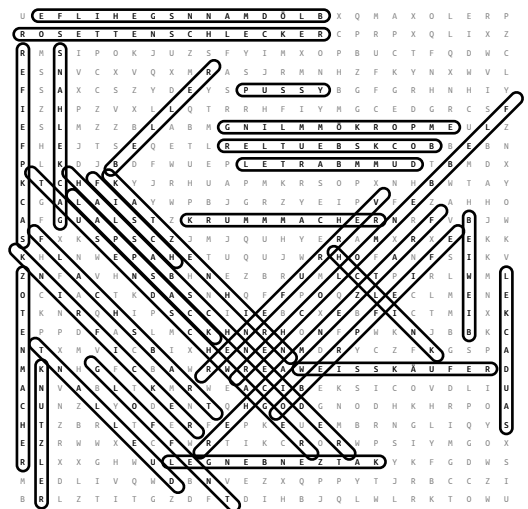

SCHIMPFWORTSUCHE 103

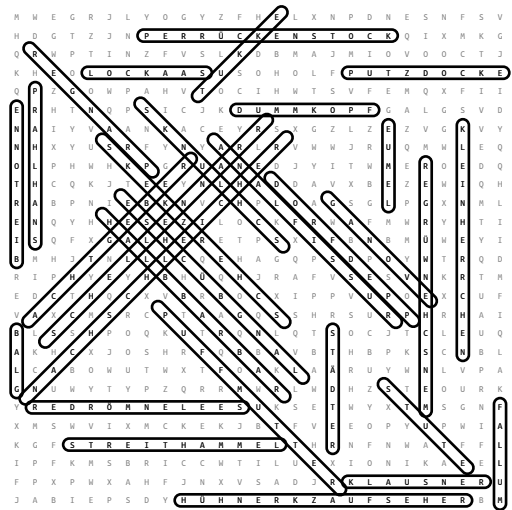

SCHIMPFWORTSUCHE 104

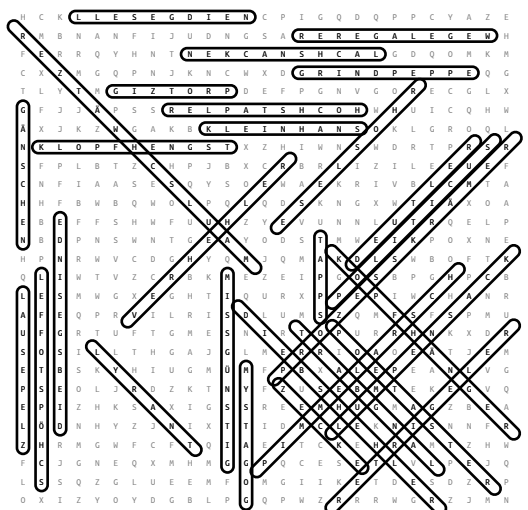

SCHIMPFWORTSUCHE 105

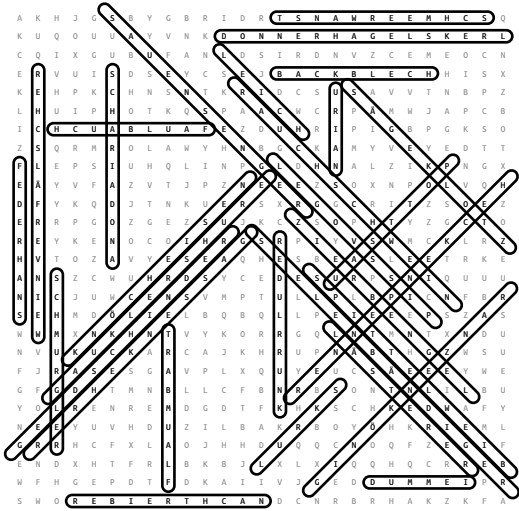

SCHIMPFWORTSUCHE 106

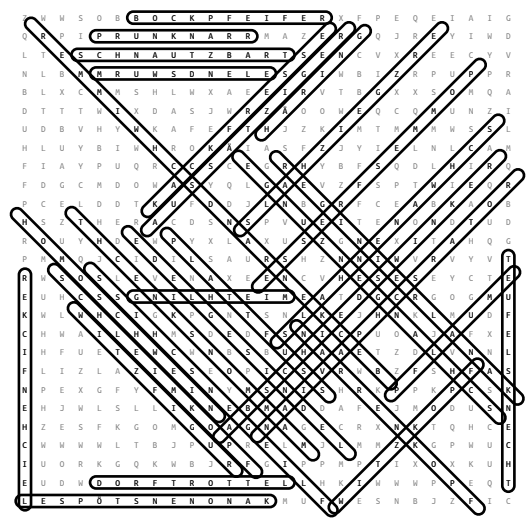

SCHIMPFWORTSUCHE 107

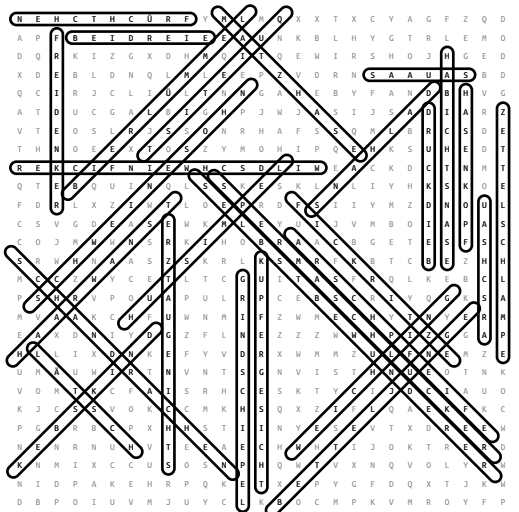

SCHIMPFWORTSUCHE 108

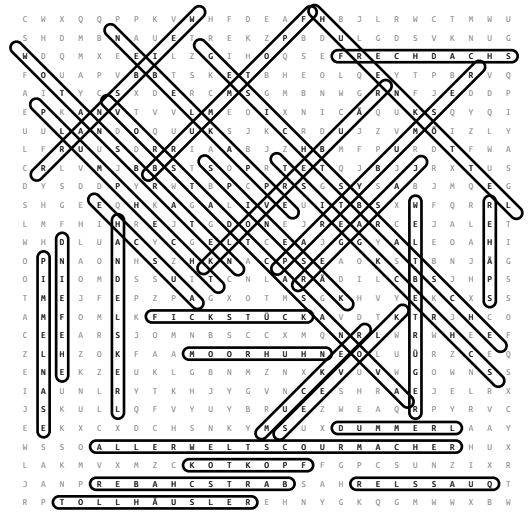

SCHIMPFWORTSUCHE 109

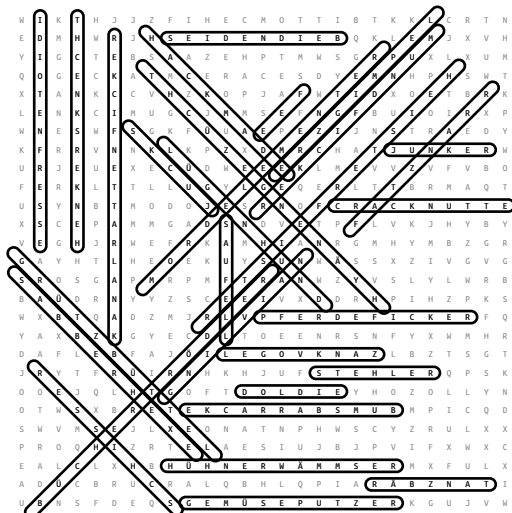

SCHIMPFWORTSUCHE 110

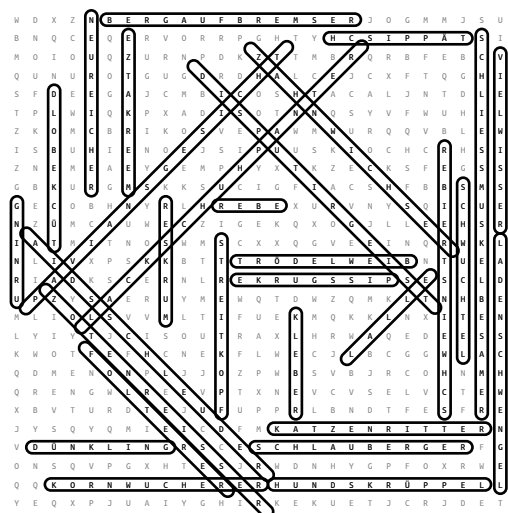

SCHIMPFWORTSUCHE 111

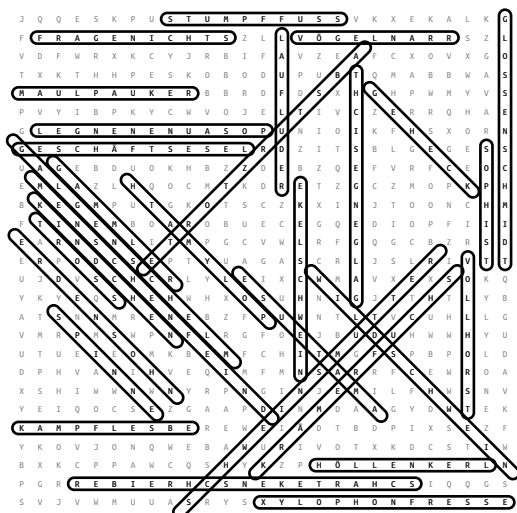

SCHIMPFWORTSUCHE 112

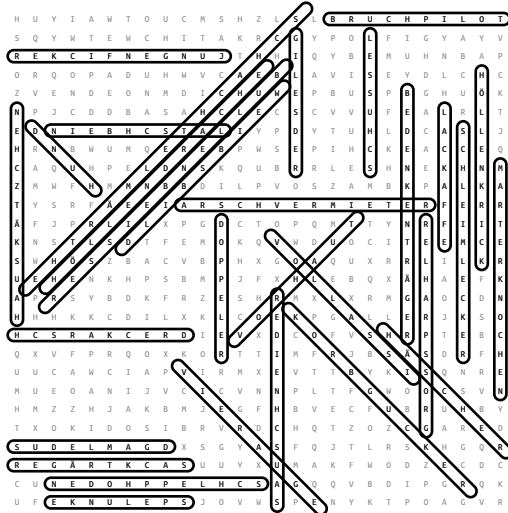

SCHIMPFWORTSUCHE 113

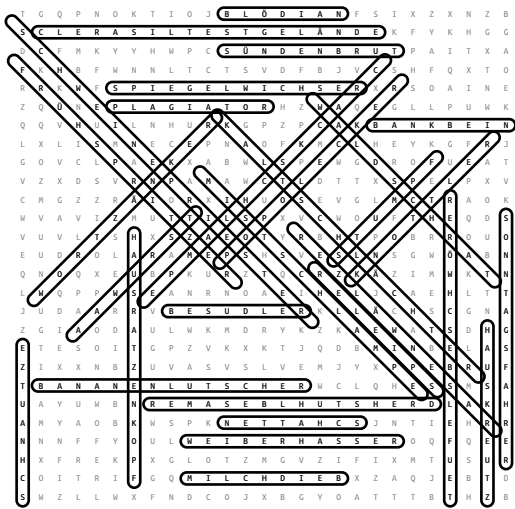

SCHIMPFWORTSUCHE 114

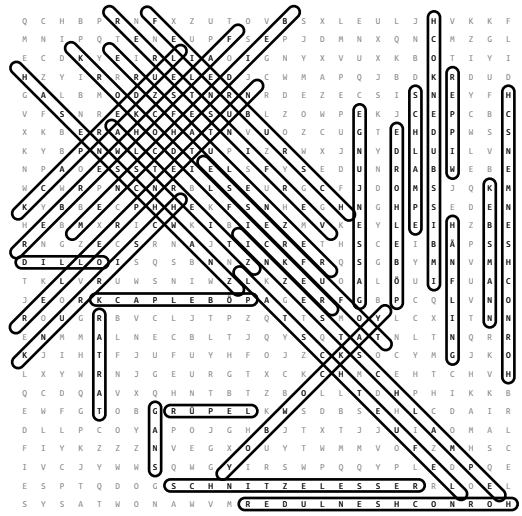

SCHIMPFWORTSUCHE 115

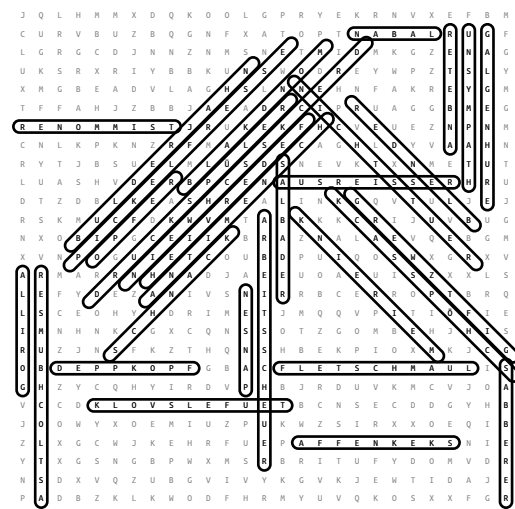

SCHIMPFWORTSUCHE 116

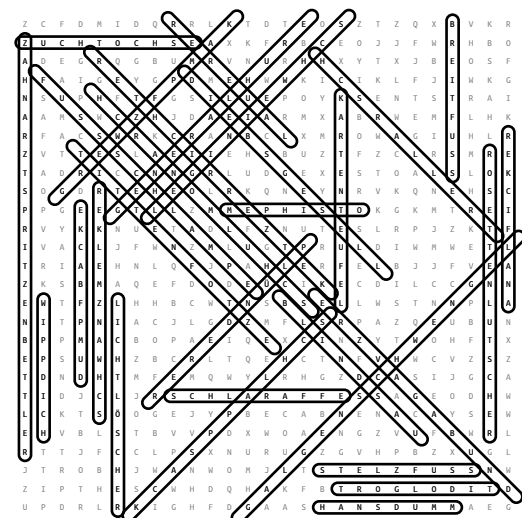

SCHIMPFWORTSUCHE 117

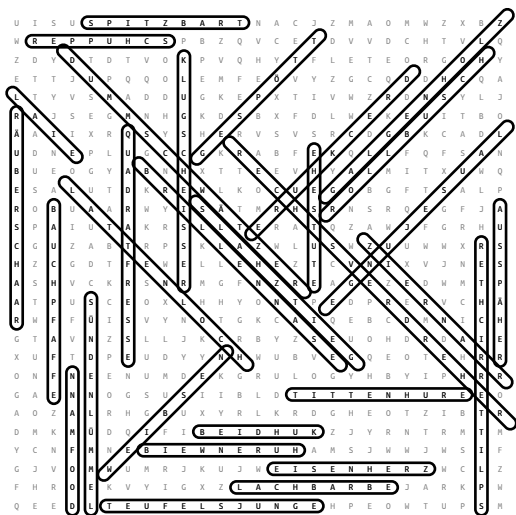

SCHIMPFWORTSUCHE 118

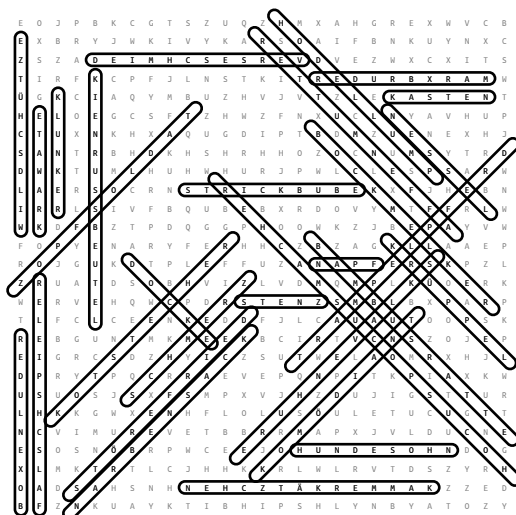

SCHIMPFWORTSUCHE 119

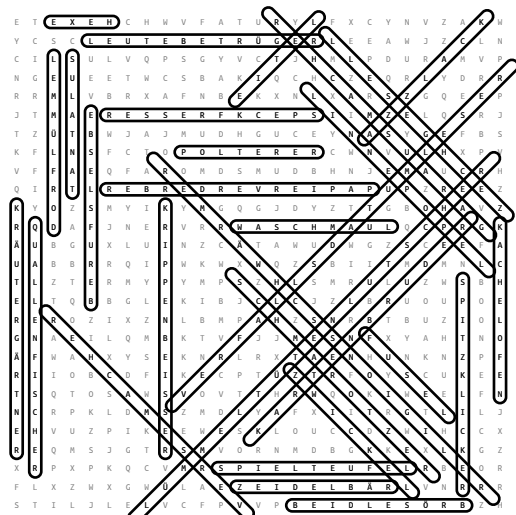

SCHIMPFWORTSUCHE 120

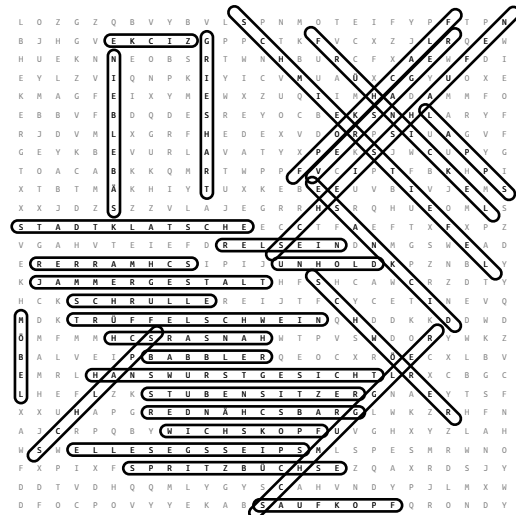

SCHIMPFWORTSUCHE 121

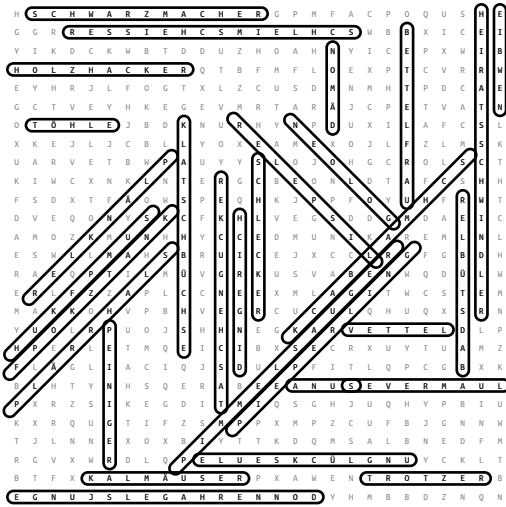

SCHIMPFWORTSUCHE 122

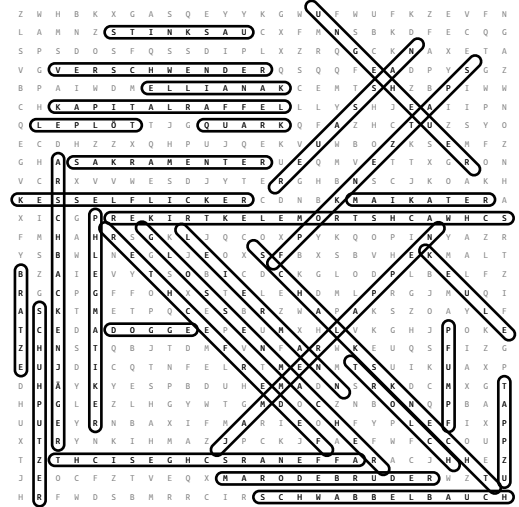

SCHIMPFWORTSUCHE 123

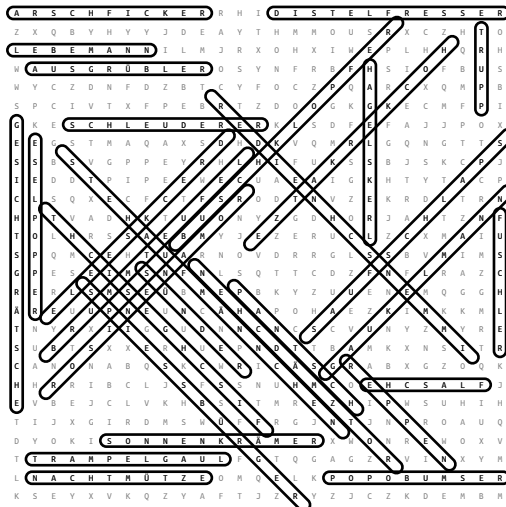

SCHIMPFWORTSUCHE 124

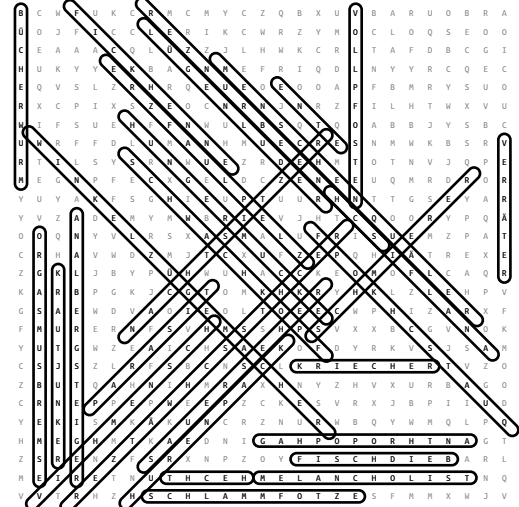

SCHIMPFWORTSUCHE 129

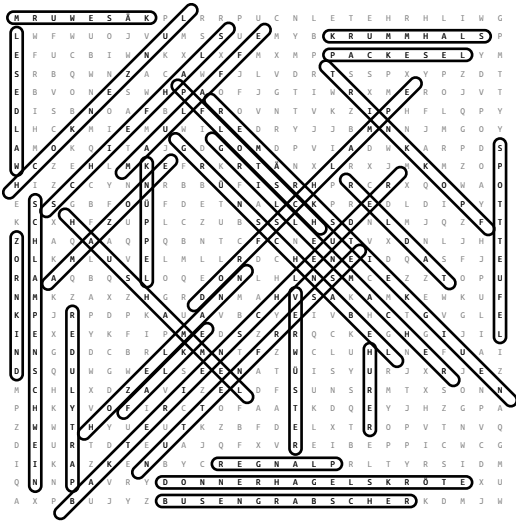

SCHIMPFWORTSUCHE 130

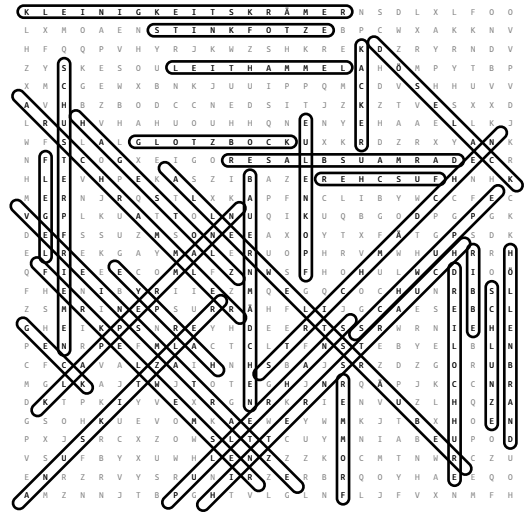

SCHIMPFWORTSUCHE 131

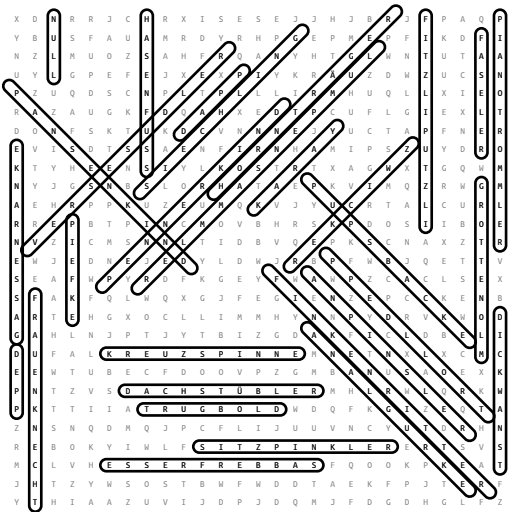

SCHIMPFWORTSUCHE 132

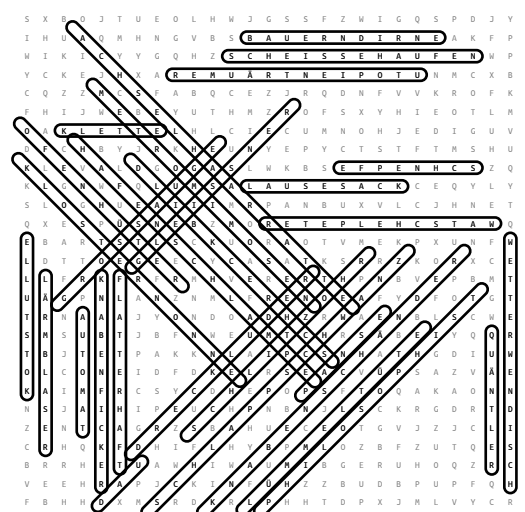

SCHIMPFWORTSUCHE 133

A grid of letters with several words highlighted in white boxes. The words are:

- RADE
- REDUELHCSNELLTIZAB
- FLUGGUCHS
- HOHLHAUS
- QUARLE
- NETZWAUTPETTSCH
- EDURBTSAN
- HINDRUEHL
- EGNEBNETTUR
- AUFSCHOSSLEIN

SCHIMPFWORTSUCHE 134

A grid of letters with several words highlighted in white boxes. The words are:

- MUSCHTICKER
- FEINSCHLAUCH
- FLASCHENKOPF
- REINDELKIN
- INDO

SCHIMPFWORTSUCHE 135

A grid of letters with several words highlighted in white boxes. The words are:

- BRILLE
- GOOPBOMME
- KRATSCHBIRNE
- WINKELRAEMER
- RETLREDDRIK
- CHMEINSKOPF

SCHIMPFWORTSUCHE 136

A grid of letters with several words highlighted in white boxes. The words are:

- EHESCHELN
- RELDRIK
- ORDENMUR
- SACKHAARFRESSER

SCHIMPFWORTSUCHE 141

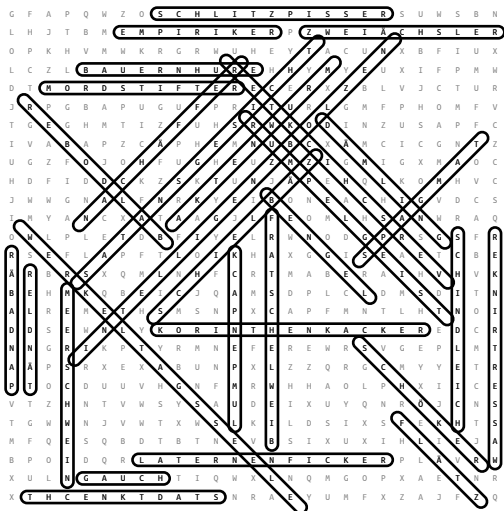

SCHIMPFWORTSUCHE 142

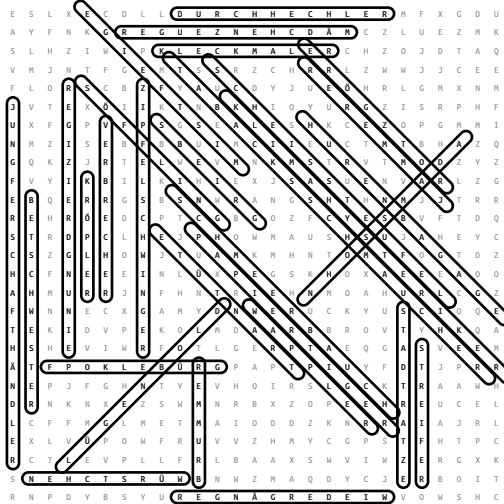

SCHIMPFWORTSUCHE 143

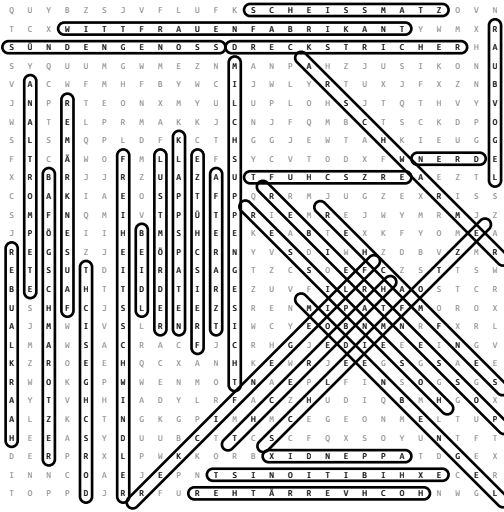

SCHIMPFWORTSUCHE 144

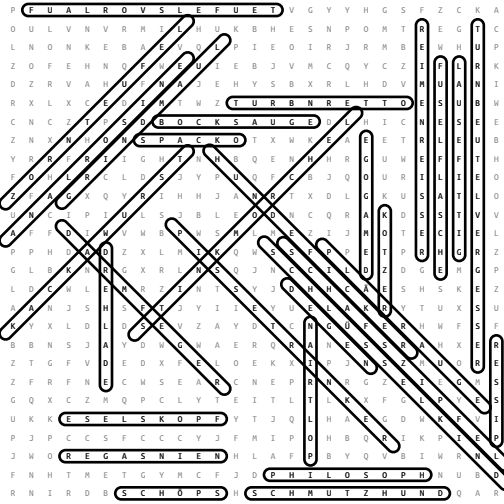

SCHIMPFWORTSUCHE 145

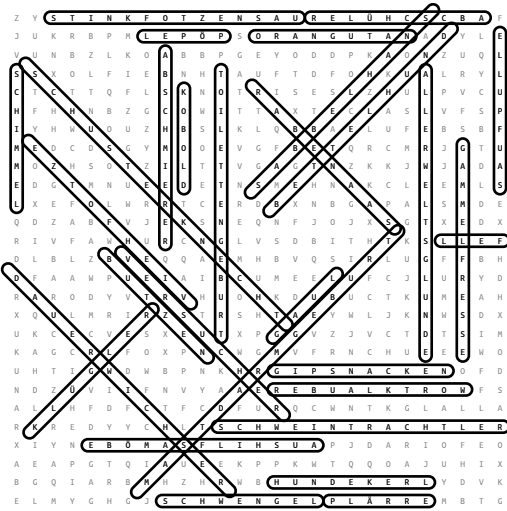

SCHIMPFWORTSUCHE 146

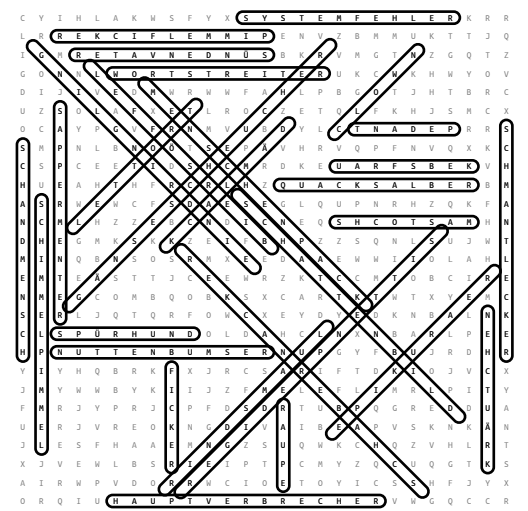

SCHIMPFWORTSUCHE 147

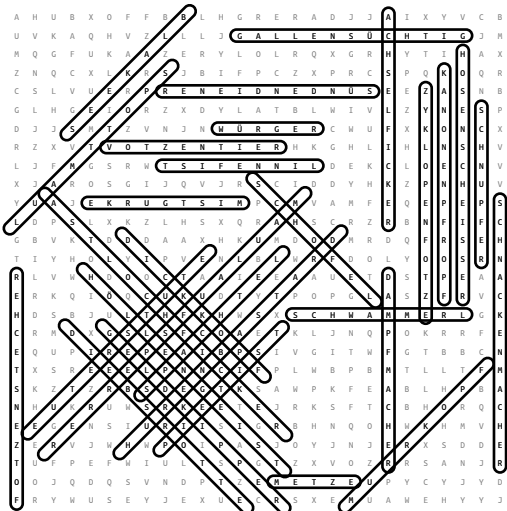

SCHIMPFWORTSUCHE 148

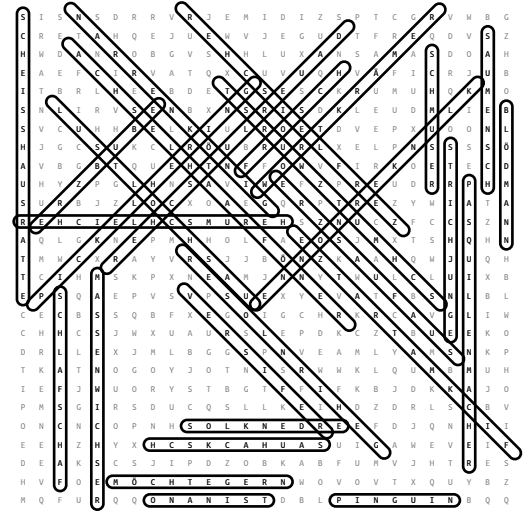

SCHIMPFWORTSUCHE 149

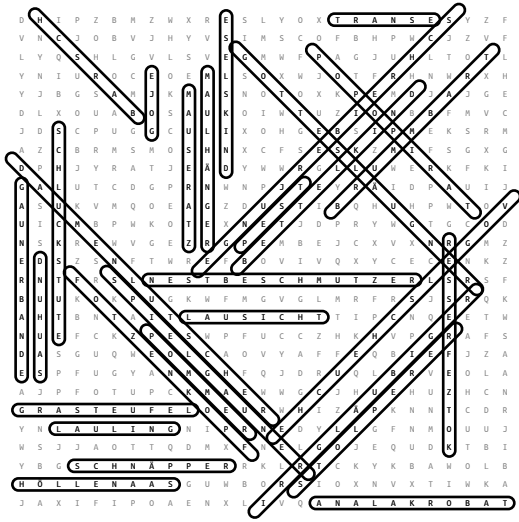

SCHIMPFWORTSUCHE 150

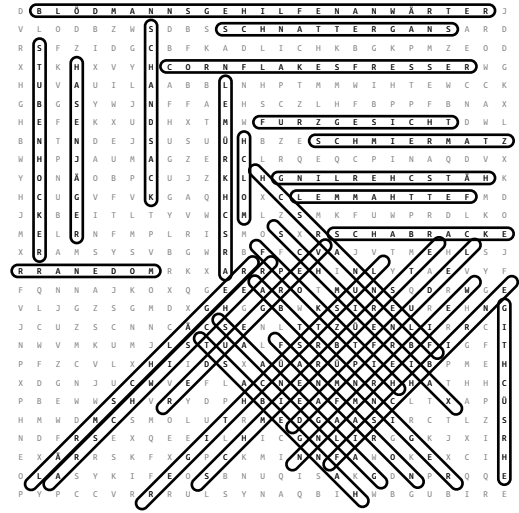

SCHIMPFWORTSUCHE 151

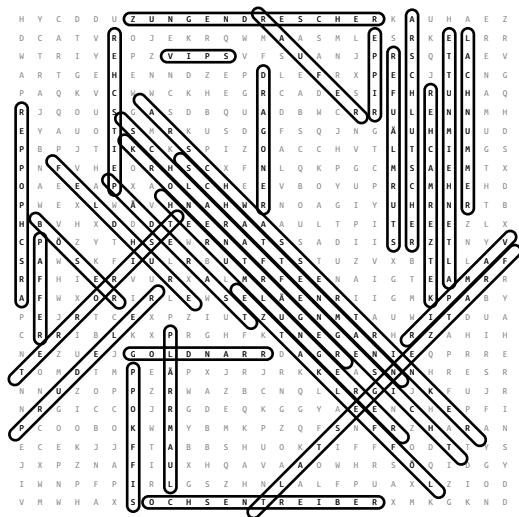

SCHIMPFWORTSUCHE 152

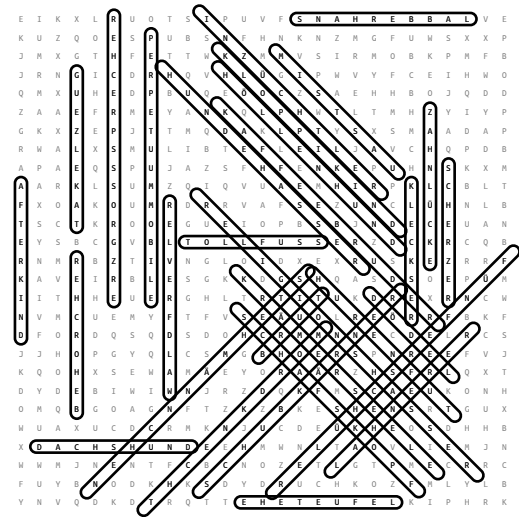

SCHIMPFWORTSUCHE 153

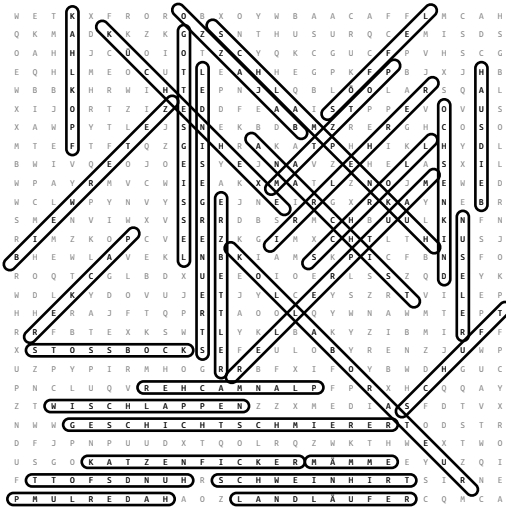

SCHIMPFWORTSUCHE 154

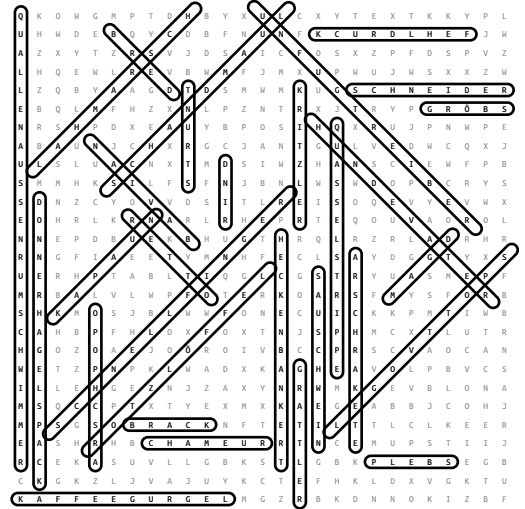

SCHIMPFWORTSUCHE 155

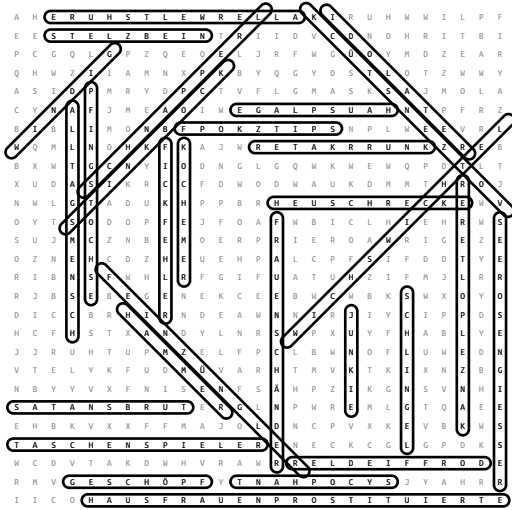

SCHIMPFWORTSUCHE 156

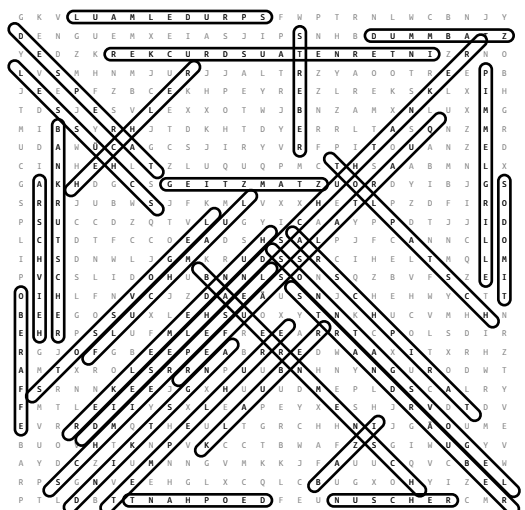

SCHIMPFWORTSUCHE 157

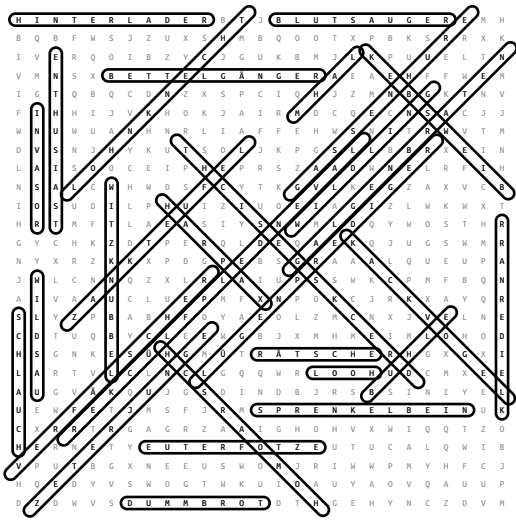

SCHIMPFWORTSUCHE 158

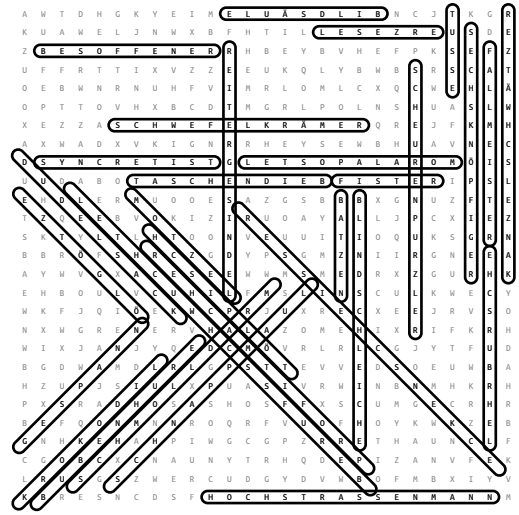

SCHIMPFWORTSUCHE 159

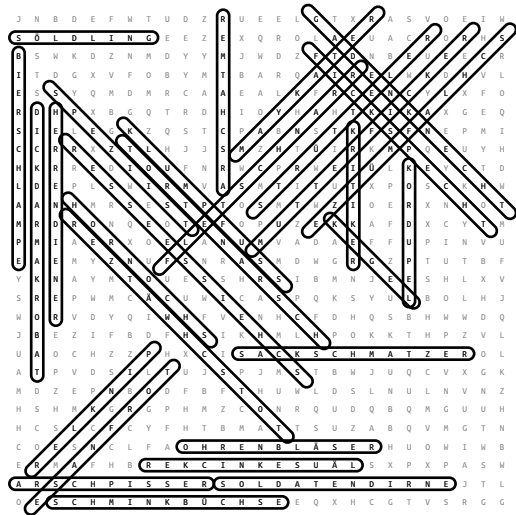

SCHIMPFWORTSUCHE 160

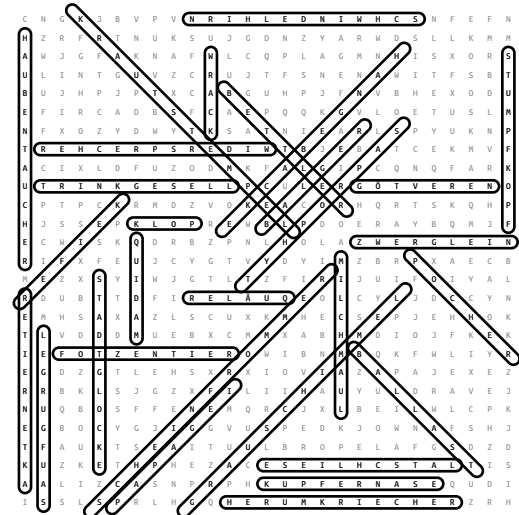

SCHIMPFWORTSUCHE 165

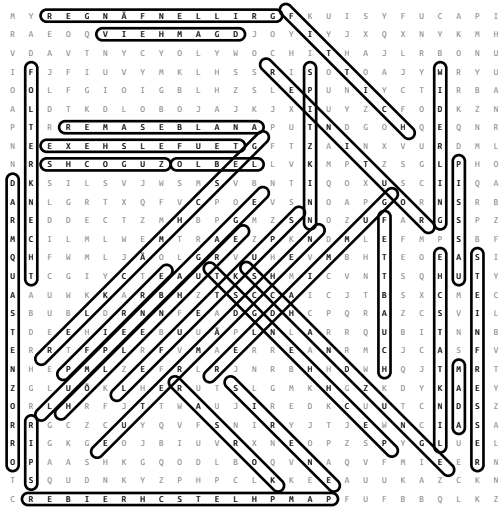

SCHIMPFWORTSUCHE 166

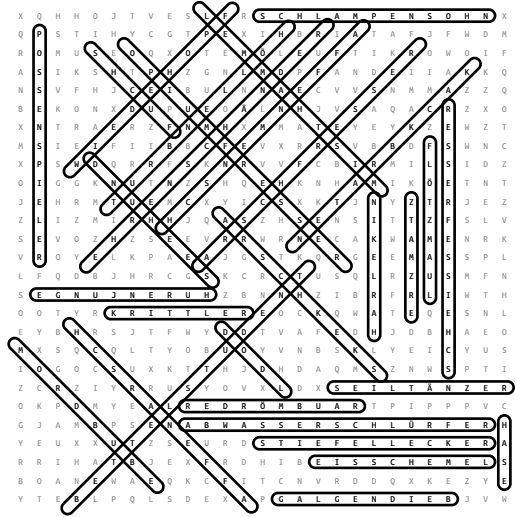

SCHIMPFWORTSUCHE 167

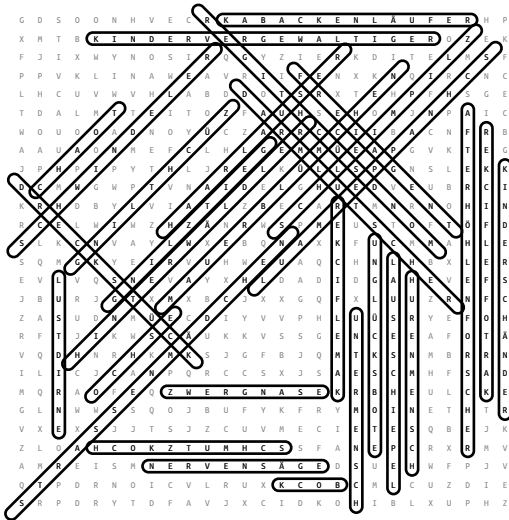

SCHIMPFWORTSUCHE 168

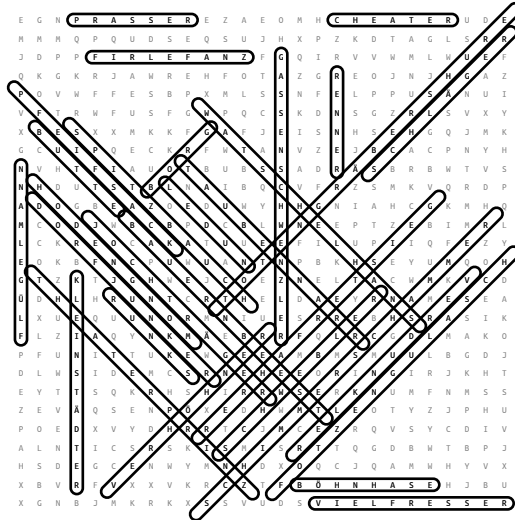

SCHIMPFWORTSUCHE 169

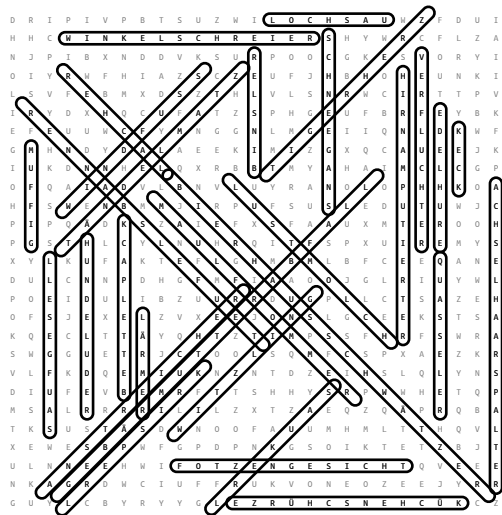

SCHIMPFWORTSUCHE 170

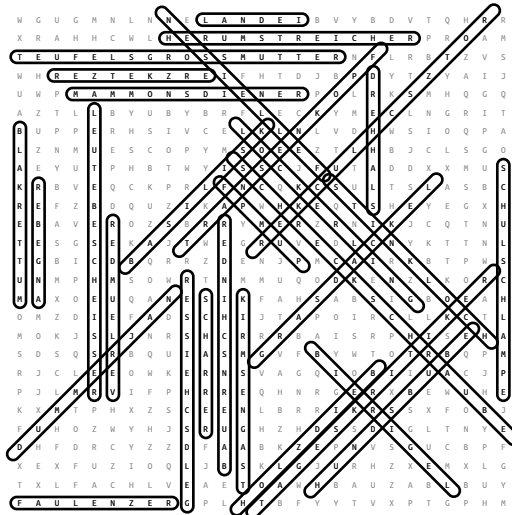

SCHIMPFWORTSUCHE 171

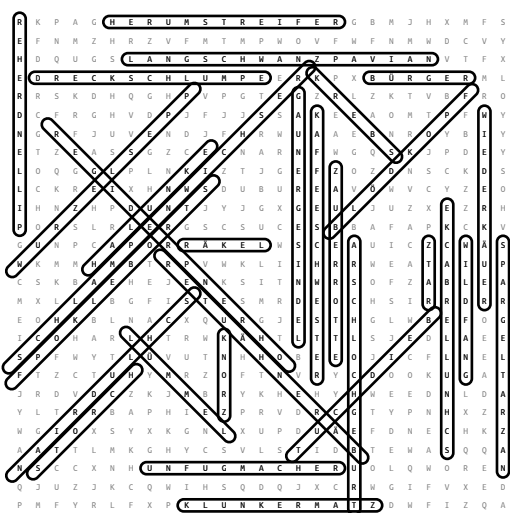

SCHIMPFWORTSUCHE 172

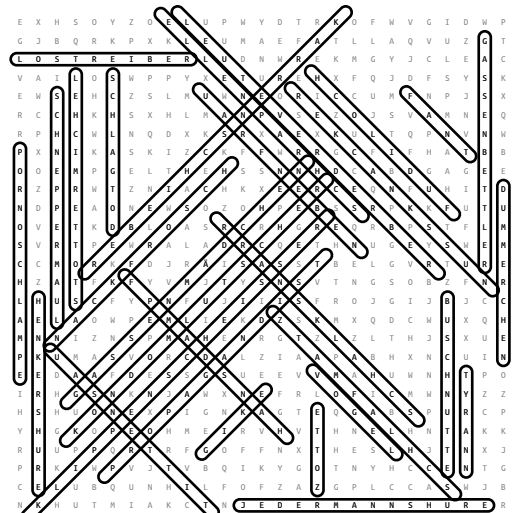

SCHIMPFWORTSUCHE 173

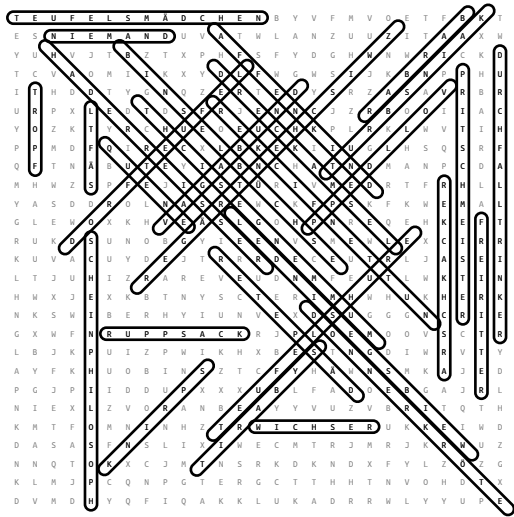

SCHIMPFWORTSUCHE 174

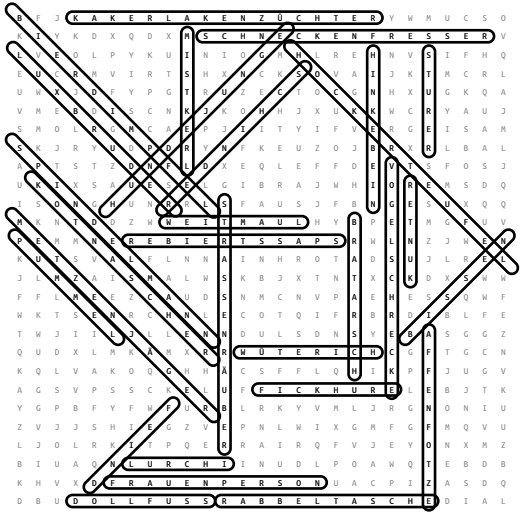

SCHIMPFWORTSUCHE 175

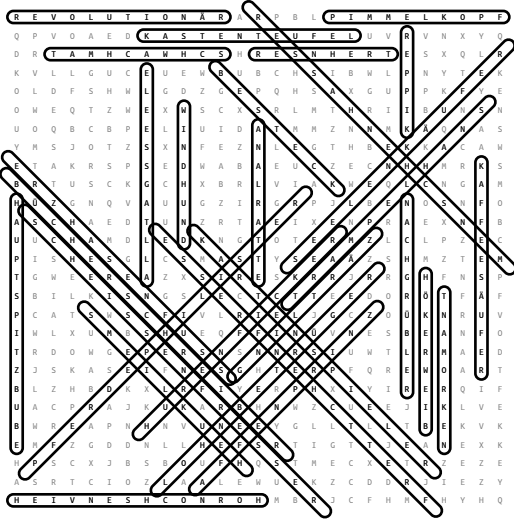

SCHIMPFWORTSUCHE 176

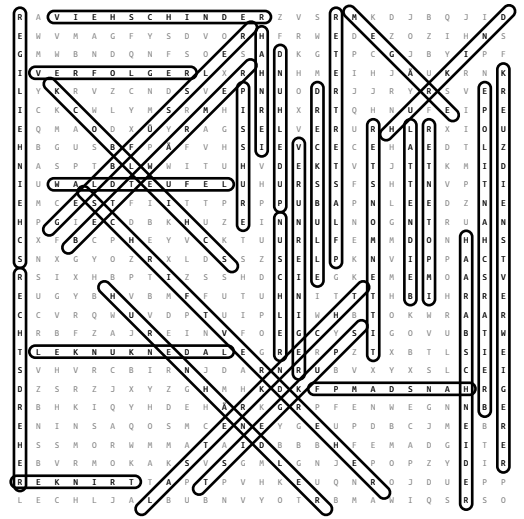

SCHIMPFWORTSUCHE 177

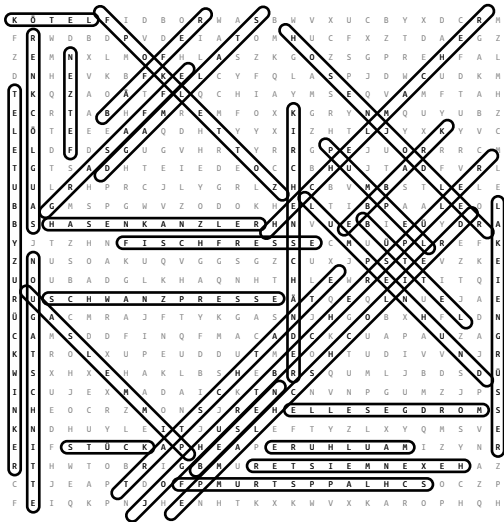

SCHIMPFWORTSUCHE 178

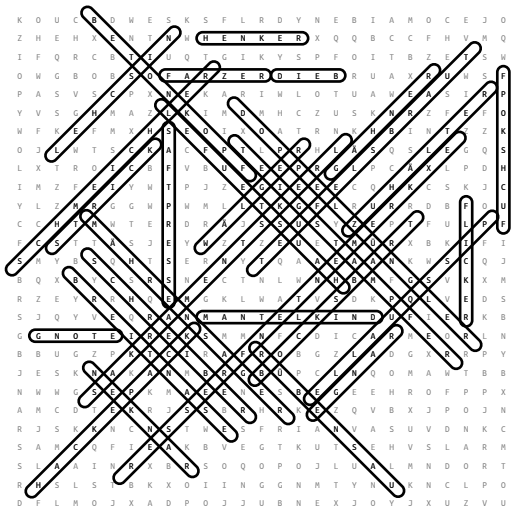

SCHIMPFWORTSUCHE 179

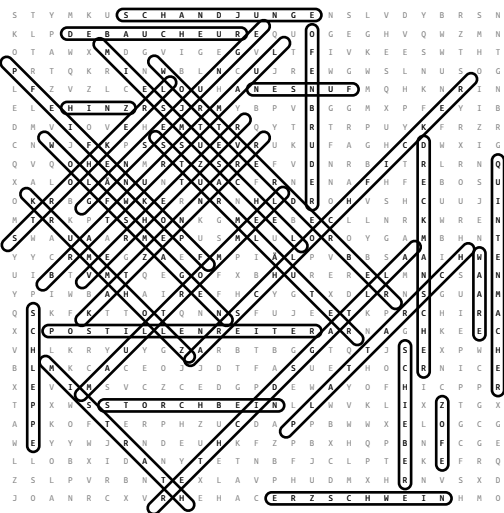

SCHIMPFWORTSUCHE 180

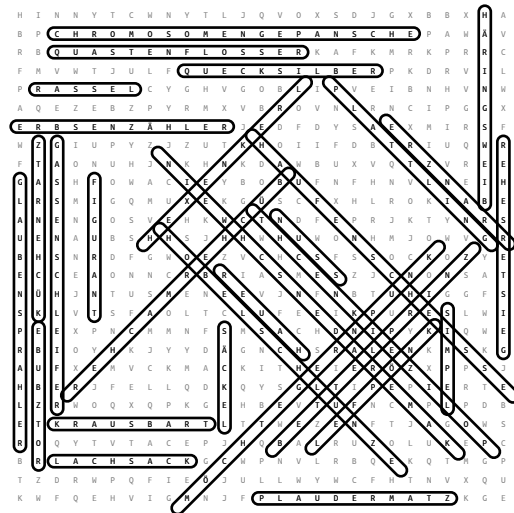

SCHIMPFWORTSUCHE 181

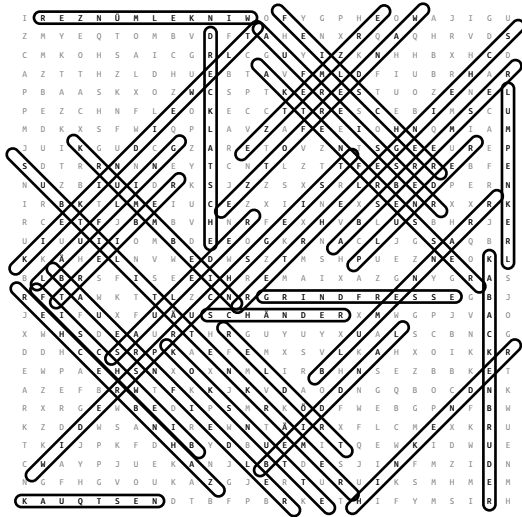

SCHIMPFWORTSUCHE 182

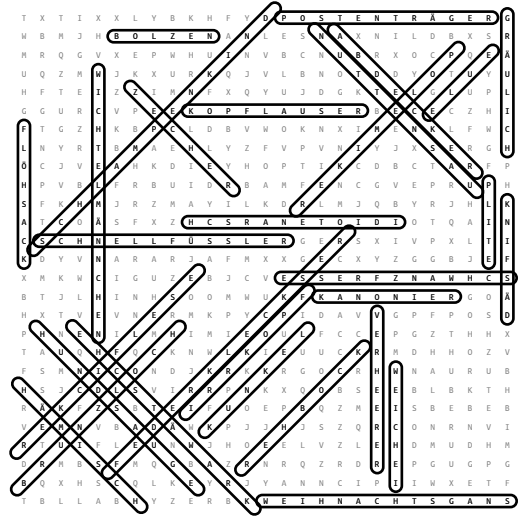

SCHIMPFWORTSUCHE 183

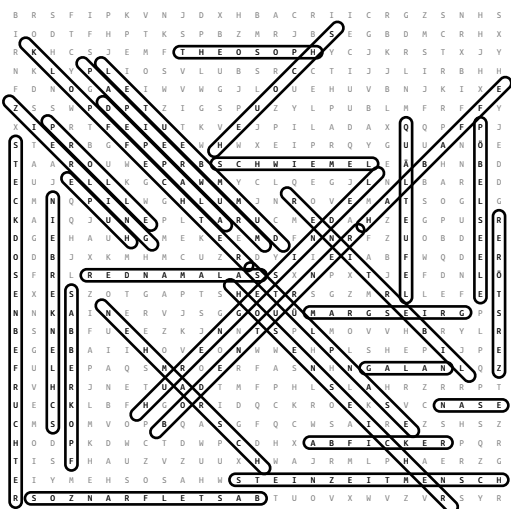

SCHIMPFWORTSUCHE 184

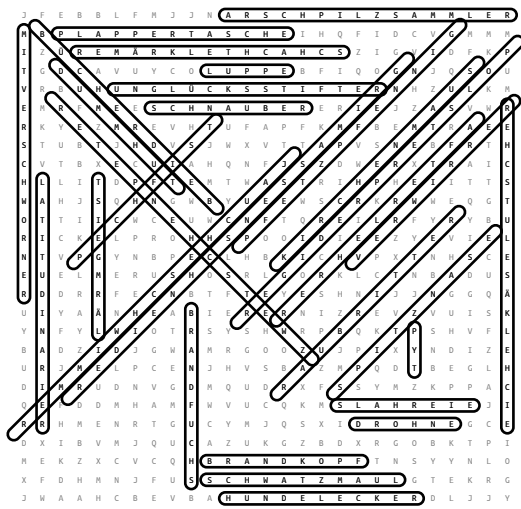

SCHIMPFWORTSUCHE 185

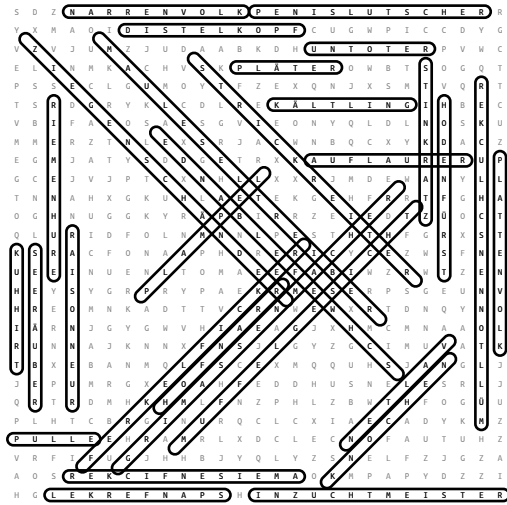

SCHIMPFWORTSUCHE 186

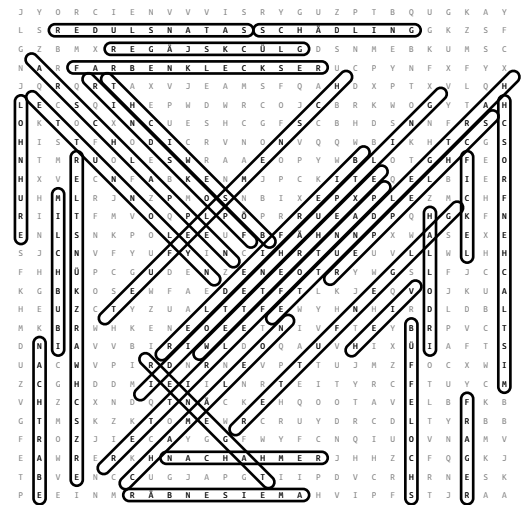

SCHIMPFWORTSUCHE 187

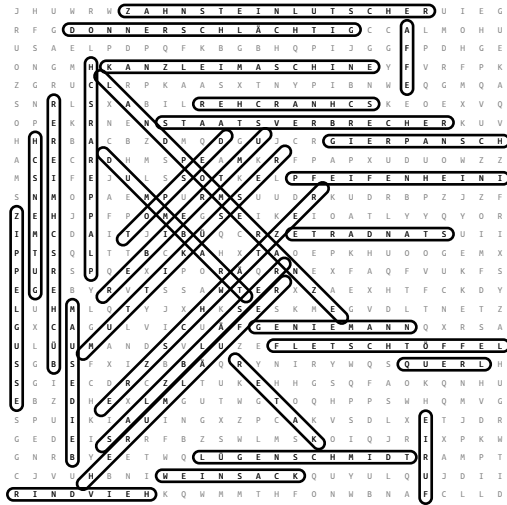

SCHIMPFWORTSUCHE 188

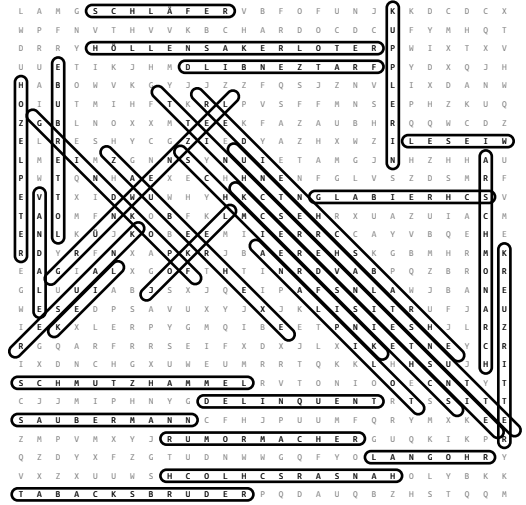

SCHIMPFWORTSUCHE 189

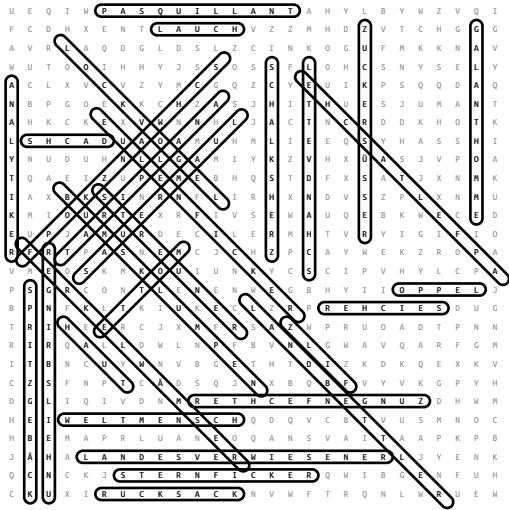

SCHIMPFWORTSUCHE 190

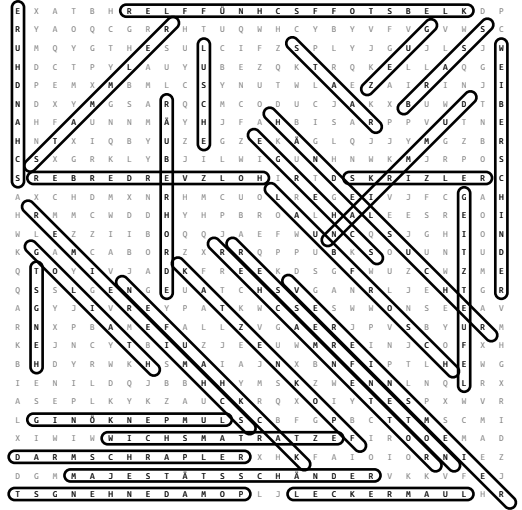

SCHIMPFWORTSUCHE 191

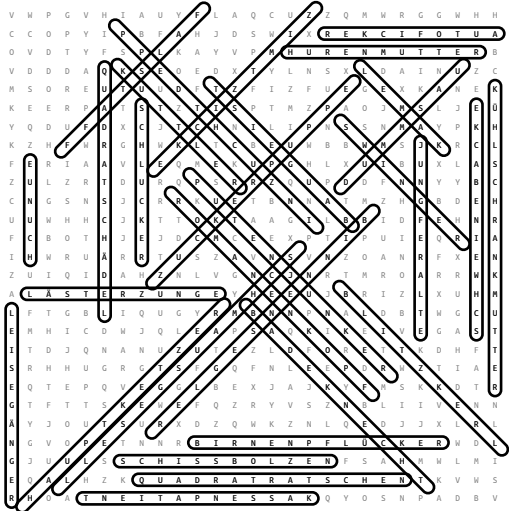

SCHIMPFWORTSUCHE 192

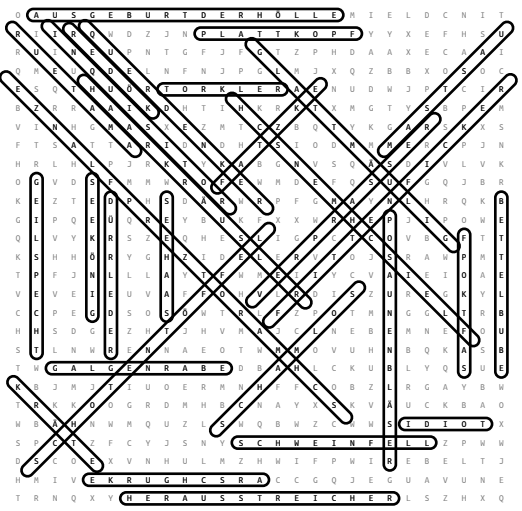

SCHIMPFWORTSUCHE 193

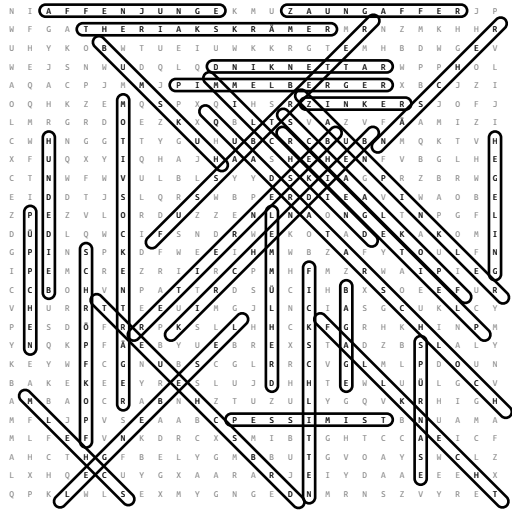

SCHIMPFWORTSUCHE 194

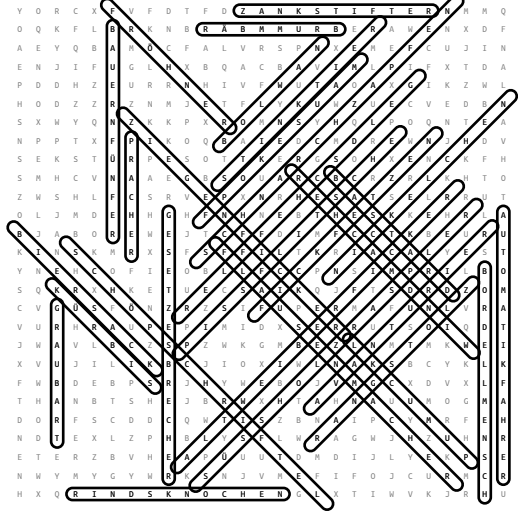

SCHIMPFWORTSUCHE 195

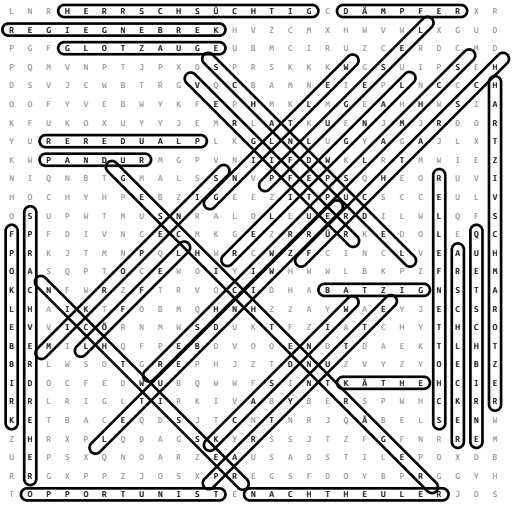

SCHIMPFWORTSUCHE 196

